



Medi Tools International

Broken Screw Extractor Removal Kit

A collection of three different kits for broken screw removal. One is in a red case, another in a silver case, and a third in a silver tray with blue handles.

Orthopedic Instrument Set
For Upper/Lower Limbs

A large blue instrument set for upper and lower limbs, shown in its open carrying case.

**ORTHOPEDICS
STERILIZATION BOX**

Three different models of orthopedic sterilization boxes in white, blue, and yellow.

[VIEW MORE +](#)



Mini fragment Instrument Kit

Item code: SET-1003 (Material: Stainless steel)

1. Top	8.Double Elevator 3mm	15.Plate Bending Wrench
2.Depth gouge	9.Double Elevator 5mm	16.Skin Retractor
3.hohmann Retractor 7/9/15	10.Point Reduciton Forceps	17.Drill bit 1.6mm
4.Screw Holding Forceps	11.Cured Reduction Holder	18. Double-end Guider 1.6-2.0mm
5.Countersink Drill	12.Plate Holder	19.Screw Driver(square) 1.2mm
6.Tip Pull Hook	13.Wire Cutter	20.Screw Box
7.Plate Bending Forceps	14.Bone Rongeurs	21.Instruments Box



Upper limb fracture instrument kit

Item code: SET-1001 (Material: Stainless steel)

1.Elevator9mm,12mm	8.Screwdriver Hex SW2.5	15.Drill bit 3.0mm
2.Bending Spanner	9.Retraction	16. Antislip Screw Driver
3.Screw Extractor	10.Screw Holder	17.Screw Tap HA3.5
4.Countersink Drill	11.Double Drill Guide 2.5	18.Screw Tap HB4.0
5.Reduciton Forceps (small)	12. Double Drill Guide 3.5	19.BoneHolding Forceps Self-Centering
6.Point Reduciton Forceps (small)	13. Double Drill Guide 4.0	20. Plate Model
7.Depth Gauges 60mm	14. Drill bit 2.5mm	21. Instrument sterilizer case



Lower limb fracture instrument kit

Item code: SET-1002 (Material: Stainless steel)

1. Hollow Reamer $\Phi 8.0$	8. Tap Cortex 4.5mm	15. Sharp Reduction Forcep 200mm
2. Screw Clamp Pliers	9. Tap Cancellous 6.5mm	16. Reduction Forcep 230mm
3. Neutral and Load Drill Guide $\Phi 3.2$	10. Drill Bit $\Phi 3.2$ 2pcs	17. Periosteal Elevator 12mm
4. Drill & Tap Guider $\Phi 4.5/\Phi 6.5$	11. Countersink $\Phi 8.0$	18. Periosteal Elevator 15mm
5. Drill & Tap Guider $\Phi 3.2/\Phi 4.5$	12. Drill Bit $\Phi 4.5$	19. Self-centering Bone Holding Forcep 270mm 2pcs
6. Screw Holder	13. Depth Gauge 90mm	20. Retractor 2pcs
7. Tap Cortex 4.5mm	14. Screwdriver Hexagonal SW3.5	21. Bender 2pcs
22. Sterilizer case		

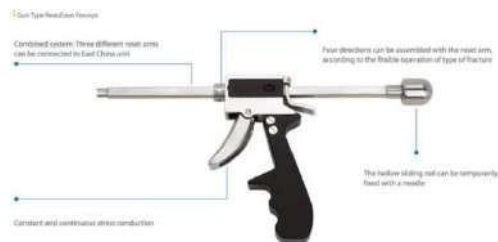

Orthopedic Collinear Reduction Clamp Instrument Set

Item code: SET-1005 (Material: Stainless steel)



Orthopedics Broken screw extractor Removal Instrument(56pcs)

Item code: BoneSET1 (Material: Stainless steel)

- | | | |
|--|---|---|
| 001 Hollow Reamer 2.0mm 1 | 019 Screwdriver Stardiver Shaft T10.2 | 040 Screw Driver Shaft "-6mm 1 |
| 002 Hollow Reamer 2.7mm 1 | 020 Screwdriver Stardiver Shaft T15.1 | 041 Screwdriver For Monoaxial Pedicle Screw 1 |
| 003 Hollow Reamer 4.0mm 1 | 021 Screwdriver Stardiver Shaft T16.1 | 042 Screwdriver For Polyaxial Pedicle Screw 1 |
| 004 Hollow Reamer 5.0mm 1 | 022 Screwdriver Stardiver Shaft T20.1 | 043 High Speed Drill Bits Ø5mm 1 |
| 005 Hollow Reamer 6.5mm 1 | 023 Screwdriver Stardiver Shaft T24.1 | 044 High Speed Drill Bits Ø6mm 1 |
| 006 Hollow Reamer 8.0mm 1 | 024 Screwdriver Stardiver Shaft T25.1 | 045 High Speed Drill Bits Ø7mm 1 |
| 007 Hollow Reamer 10mm 1 | 025 Screwdriver Stardiver Shaft T28.1 | 046 Pliers,for screw removal 1 |
| 008 Extraction Bolt 4.0mm 1 | 026 Screwdriver Shafts Hexagonal Ø1.5mm 1 | 047 T-Handle,AO QC 1 |
| 009 Extraction Bolt 5.0mm 1 | 027 Screwdriver Shafts Hexagonal Ø2.0mm 1 | 048 Straight Handle,AO QC 1 |
| 010 Extraction Bolt 6.0mm 1 | 028 Screwdriver Shafts Hexagonal Ø2.5mm 2 | 049 Round Gouge, width 10mm 1 |
| 011 Extraction Screw Hexagonal 2.5,Conical 1 | 029 Screwdriver Shafts Hexagonal Ø3.0mm 1 | 050 Screw Extractor 3.5mm 1 |
| 012 Extraction Screw Hexagonal 2.7,Conical 1 | 030 Screwdriver Shafts Hexagonal Ø3.5mm 1 | 051 Screw Extractor 4.5mm 1 |
| 013 Extraction Screw Hexagonal 3.5,Conical 1 | 031 Screwdriver Shafts Hexagonal Ø4.0mm 1 | 052 Awl 1 |
| 014 Extraction Screw Hexagonal 4.0,Conical 1 | 032 Screwdriver Shafts Hexagonal Ø4.5mm 1 | 053 Sharp Hook 1 |
| 015 Screwdriver Stardiver Shaft T5 1 | 033 Screwdriver Shafts Hexagonal Ø5.0mm 1 | 054 Container 1 |
| 016 Screwdriver Stardiver Shaft T6 1 | 034 Screwdriver Shafts Hexagonal Ø5.5mm 1 | 055 Sterilizer case |
| 017 Screwdriver Stardiver Shaft T7 1 | 035 Cruciform screwdriver Shafts Ø3.0 1 | |
| 018 Screwdriver Stardiver Shaft T8 1 | 036 Screwdriver Shafts Square 1.2mm 1 | |
| | 037 Screwdriver Shafts Square 1.5mm 1 | |
| | 038 Screwdriver Shafts Triangle 2.0mm 1 | |
| | 039 Screw Driver Shaft "-9mm 1 | |



53pcs
Orthopedic set



Orthopedics Broken screw extractor Removal Instrument (53pcs)

Item code: BoneSET1-1 (Material: Stainless steel)

53pcs Contain:

- | | |
|---|---|
| 001 Hollow Reamer 2.0mm 1 | 026 Screwdriver Stardiver Shaft T3.0mm 1 |
| 002 Hollow Reamer 2.7mm 1 | 027 Screwdriver Stardiver Shaft T3.4mm 1 |
| 003 Hollow Reamer 4.0mm 1 | 028 Screwdriver Stardiver Shaft T4.0mm 1 |
| 004 Hollow Reamer 5.0mm 1 | 029 Screwdriver Stardiver Shaft T4.3mm 1 |
| 005 Hollow Reamer 6.5mm 1 | 030 Screwdriver Stardiver Shaft T4.5mm 1 |
| 006 Hollow Reamer 8.0mm 1 | 031 Screwdriver Stardiver Shaft T5.0mm 1 |
| 007 Screwdriver For Monoaxial Pedicle Screw 1 | 032 Screwdriver Stardiver Shaft T5.3mm 1 |
| 008 Screwdriver For Polyaxial Pedicle Screw 1 | 033 Screwdriver Shafts Hexagonal Ø1.5mm 1 |
| 009 Screw Driver Shaft "-3mm 1 | 034 Screwdriver Shafts Hexagonal Ø2.0mm 1 |
| 010 Screw Driver Shaft "-6mm 1 | 035 Screwdriver Shafts Hexagonal Ø2.5mm 1 |
| 011 Extraction Bolt 4.0mm 1 | 036 Screwdriver Shafts Hexagonal Ø3.0mm 1 |
| 012 Extraction Bolt 5.0mm 1 | 037 Screwdriver Shafts Hexagonal Ø3.5mm 1 |
| 013 Extraction Bolt 6.5mm 1 | 038 Screwdriver Shafts Hexagonal Ø4.0mm 1 |
| 014 Cruciform screwdriver Shafts Ø3.0 1 | 039 Screwdriver Shafts Hexagonal Ø4.5mm 1 |
| 015 Screwdriver Shafts Square 1.2mm 1 | 040 Screwdriver Shafts Hexagonal Ø5.0mm 1 |
| 016 Extraction Screw Hexagonal 2.5,Conical 1 | 041 Screwdriver Shafts Hexagonal Ø5.5mm 1 |
| 017 Extraction Screw Hexagonal 2.7,Conical 1 | 042 Round Gouge, width 8mm 1 |
| 018 Extraction Screw Hexagonal 3.5,Conical 1 | 043 Screw Extractor 3.5mm 1 |
| 019 Extraction Screw Hexagonal 4.0,Conical 1 | 044 Screw Extractor 4.5mm 1 |
| 020 Screwdriver Stardiver Shaft T1.5mm 1 | 045 Awl 1 |
| 021 Screwdriver Stardiver Shaft T1.75mm 1 | 046 Sharp Hook 1 |
| 022 Screwdriver Stardiver Shaft T 2.0mm 1 | 047 High Speed Drill Bits Ø5mm 1 |
| 023 Screwdriver Stardiver Shaft T 2.3mm 1 | 048 High Speed Drill Bits Ø6mm 1 |
| 024 Screwdriver Stardiver Shaft T 2.7mm 1 | 049 High Speed Drill Bits Ø4mm 1 |
| 025 Screwdriver Stardiver Shaft T 2.7mm 1 | 050 T-Handle,AO QC 1 |
| | 051 Straight Handle,AO QC 1 |
| | 052 Pliers,for screw removal 1 |
| | 053 Container 1 |



Orthopedics Broken screw extractor Removal Instrument(56pcs)

Item code: SET-1045 (Material: Stainless steel)

Contain:

- 01 Screwdriver Shafts Square 1.2mm 1
- 02 Screwdriver Shafts Square 1.5mm 1
- 03 Screwdriver Shafts triangle 1.5mm 1
- 04 Screwdriver Shafts triangle 2.0mm 1
- 05 Extraction Bolt 4.0mm 1
- 06 Extraction Bolt 5.0mm 1
- 07 Extraction Bolt 6.0mm 1
- 08 Cruciform screwdriver Shafts Φ 2mm 1
- 09 Screw Driver Shaft "-"3mm 1
- 010 Screw Driver Shaft "-"6mm 1
- 011 Screwdriver Stardiver Shaft T1.0.1
- 012 Screwdriver Stardiver Shaft T1.2.1
- 013 Screwdriver Stardiver Shaft T1.5.1
- 014 Screwdriver Stardiver Shaft T1.75.1
- 015 Screwdriver Stardiver Shaft T2.0.1
- 016 Screwdriver Stardiver Shaft T2.3.1
- 017 Screwdriver Stardiver Shaft T2.5.1
- 018 Screwdriver Stardiver Shaft T2.7.1
- 019 Screwdriver Stardiver Shaft T3.0.1
- 020 Screwdriver Stardiver Shaft T3.3.1
- 021 Screwdriver Stardiver Shaft T3.4.1
- 022 Screwdriver Stardiver Shaft T3.9.2
- 023 Screwdriver Stardiver Shaft T4.3.1
- 024 Screwdriver Stardiver Shaft T4.5.1
- 025 Screwdriver Stardiver Shaft T5.0.1
- 026 Screwdriver Stardiver Shaft T5.3.1
- 027 Screwdriver Stardiver Shaft T5.5.1

- 028 Screwdriver Shafts Hexagonal SW 1.0mm 1
- 029 Screwdriver Shafts Hexagonal SW 1.2mm 1
- 030 Screwdriver Shafts Hexagonal SW 1.5mm 1
- 031 Screwdriver Shafts Hexagonal SW 2.0mm 1
- 032 Screwdriver Shafts Hexagonal SW 2.5mm 1
- 033 Screwdriver Shafts Hexagonal SW 3.0mm 1
- 034 Screwdriver Shafts Hexagonal SW 3.5mm 1
- 035 Screwdriver Shafts Hexagonal SW 4.0mm 1
- 036 Screwdriver Shafts Hexagonal SW 4.5mm 1
- 037 Screwdriver Shafts Hexagonal SW 5.0mm 1
- 038 Screwdriver Shafts Hexagonal SW 5.5mm 1
- 039 Extraction Screw Hexagonal 2.5,Conical 1
- 040 Extraction Screw Hexagonal 2.7,Conical 1
- 041 Extraction Screw Hexagonal 3.5,Conical 1
- 042 Extraction Screw Hexagonal 4.0,Conical 1
- 043 Hollow Reamer 2.0mm 1
- 044 Hollow Reamer 2.7mm 1
- 045 Hollow Reamer 4.0mm 1
- 046 Hollow Reamer 5.0mm 1
- 047 Hollow Reamer 6.5mm 1
- 048 Hollow Reamer 8.0mm 1
- 049 Hollow Reamer 10mm 1
- 050 Awl 1
- 051 Sharp Hook 1
- 052 T-Handle,AO QC 1
- 053 Straight Handle,AO QC 1
- 054 Screw Extractor 3.5mm 1
- 055 Screw Extractor 4.5mm 1
- 056 Pliers,for screw removal 1

- 057 Round Gouge, width 8mm 1
- 058 High Speed Drill Bits Φ 5mm 1
- 059 High Speed Drill Bits Φ 6mm 1
- 060 High Speed Drill Bits Φ 7mm 1
- 061 Screwdriver For Monoaxial Pedicle Screw 1
- 062 Screwdriver For Polyaxial Pedicle Screw 1
- 063 Instrument case 1



Orthopedics fracture reduction instrument kit

Item code: SET-1008 (Material: Stainless steel)



Orthopedics Broken screw extractor Removal Instrument

Item code: SET-1009 (Material: Stainless steel)



Orthopedic multifunctional Kirschner wire spreader instrument set

Item code: SET-1011 (Material: Stainless steel)

Multifunctional K-Wire Spreader Instruments Set

- 2pcs Kirschner wires 1.5*250mm
- 2pcs Kirschner wires 2.0*250mm
- 2pcs Kirschner wires 2.5*250mm
- 2pcs Kirschner wires 3.0*250mm
- 2pcs Kirschner wires 3.5*250mm
- 2pcs Kirschner wires 4.0*250mm
- 2pcs Distract Sleeve 1.5mm

- 2pcs Distract Sleeve 1.5mm
- 2pcs Distract Sleeve 2.0mm
- 2pcs Distract Sleeve 2.5mm
- 2pcs Distract Sleeve 3.0mm
- 2pcs Distract Sleeve 3.5mm
- 1pcs Self-Locking Wrench
- 1pcs Multifunctional Ankle K-Wire Retractor
- 1pcs Sterilization Box



Orthopedic Meniscus suture Wire pass thread instrument set

Item code: SET-1010 (Material: Stainless steel)



Orthopedic 4.5 Cannulated Screw Instrument Kit (4.5)

Item code: SET-1012 (Material: Stainless steel)

- ① Clean guide pin 1pcs
- ② Partial threaded Kirschner wires 1.5*150mm 3pcs
- ③ Guide Pin 1.5*150mm 3pcs
- ④ Cannulated Drill 3.2*150mm 1pcs
- ⑤ Drill Guide 1.5-3.2mm 1pcs
- ⑥ L Wrench 1pcs
- ⑦ Cannulated Hex Screw Driver SW2.5mm 1pcs
- ⑧ Hex Screw Driver SW2.5mm 1pcs
- ⑨ Cannulated Tap HB4.5mm 1pcs
- ⑩ Cannulated Countersink Drill 6mm 1pcs
- ⑪ Guide Pin Depth Gauge 0-60mm 1pcs
- ⑫ Sterilizing Box 1pcs



Orthopedic 6.5 Cannulated Screw Instrument Kit (6.5)

Item code: SET-1013 (Material: Stainless steel)

6.5mm Cannulated Screw Instrument Kit

- 1. L Wrench 1pcs
- 2. Guide Pin 2.0*250mm 3pcs
- 3. partial threaded Kirschner wires 2.0*250mm 3pcs
- 4. Multi-Hole Guider 1pcs
- 5. Drill Guide 1pcs
- 6. Two Hole Guider 1pcs
- 7. Cannulated Hex Screw Driver SW4.0mm 1pcs
- 8. Hex Screw Driver SW4.0mm 1pcs
- 9. Cannulated Countersink Drill 8mm 1pcs
- 10. Cannulated Tap HB6.5mm 1pcs
- 11. Clean guide pin 1pcs
- 12. Guide Pin Depth Gauge 0-150mm 1pcs
- 13. Cannulated Drill 5.0mm 1pcs
- 14. Stopper 1pcs
- 15. Sterilizing Box 1pcs



Orthopedic 7.3 Cannulated Screw Instrument Kit (7.3)

Item code: SET-1014 (Material: Stainless steel)

7.3mm Cannulated Screw Instrument Kit

- | | |
|--|--|
| 1. L Wrench 1pcs | 9. Cannulated Countersink Drill 8mm 1pcs |
| 2. Guide Pin 2.0*250mm 3pcs | 10. Cannulated Tap HB 7.3mm 1pcs |
| 3. partial threaded Kirschner wires 2.0*250mm 3pcs | 11. Clean guide pin 1pcs |
| 4. Multi-Hole Guider 1pcs | 12. Guide Pin Depth Gauge 0-150mm 1pcs |
| 5. Drill Guide 1pcs | 13. Cannulated Drill 5.0mm 1pcs |
| 6. Two Hole Guider 1pcs | 14. Stopper 1pcs |
| 7. Cannulated Hex Screw Driver SW4.0mm 1pcs | 15. Sterilizing Box 1pcs |
| 8. Hex Screw Driver SW4.0mm 1pcs | |



Orthopedic AO Upper Limb Locking Plate Instrument Kit (A0)

Item code: SET-1015 (Material: Stainless steel)

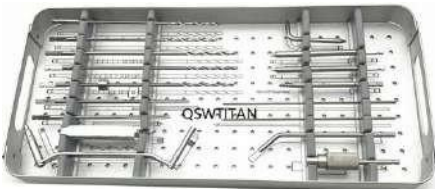

(The first layer)



(The Second-layer)

- ⑧ Torque Handle 1.5 N.m 1pcs
- ⑨ AO Quick coupling Handle 1pcs
- ⑩ Hex Screwdriver 2.5 mm 1pcs
- ⑪ Periosteal Elveator 9mm Round head 1pcs
- ⑫ Periosteal Elveator 12mm square head 1pcs
- ⑬ Depth Gauges 0-60mm 1pcs
- ⑭ Pin Sleeve Drill 1.5mm 2pcs
- ⑮ Drill Bit Sleeve 3.2mm 6pcs
- ⑯ T Quick coupling Handle 1pcs
- ⑰ Lifting Drill 1pcs



(The Third-layer)





Orthopedic A0 Lower Limb Locking Plate Instrument Kit (A0)

Item code: SET-1016 (Material: Stainless steel)



The first Layer



The second Layer



The Third Layer





The first layer

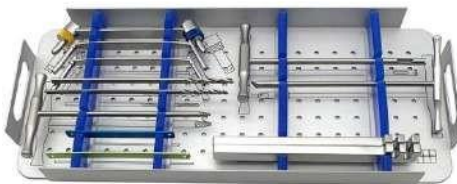

The second layer



The third layer



Upper Limbs fracture instrumets kit

Item code: SET-1017 Total 3 layer

Material: Stainless steel



- ① Drill Bits Guider Sleeve 2.5mm 1pcs
- ② Drill Bits Guider Sleeve 3.0mm/4.0mm 1pcs
- ③ Drill Bits Guider Sleeve 2.5mm/3.5mm 1pcs
- ④ Drill 2.0*15mm 2pcs
- ⑤ Drill 3.0*15mm 2pcs
- ⑥ Screw Extractor 1pcs
- ⑦ Hollow Reamer 6mm
- ⑧ Countersink drill 6mm 1pcs
- ⑨ Plate Bending Forces 2*1
- ⑩ Template 10*97mm 1pcs
- ⑪ Template 10*114mm 1pcs



- ⑫ Screw Tap HA3.5mm 1pcs
- ⑬ Screw Tap A4.0mm 1pcs
- ⑭ Screw Holder 1pcs
- ⑮ Periosteal Elevator 12mm square head 1pcs
- ⑯ Periosteal Elevator 9mm square head 1pcs
- ⑰ Retractor 15mm 2pcs
- ⑱ Depth Gauges 0-60mm 1pcs



- ⑳ Hex Screwdriver 2.5mm 1pcs
- ㉑ Pointed Reduction Forceps 190mm 1pcs
- ㉒ Self-centering Forceps 190mm 2pcs
- ㉓ Curved Reduction Forceps 180mm 1pcs
- ㉔ Screw box



Lower Limbs fracture instrumets kit

Item code: SET-1018 Total 3 layer

Material: Stainless steel

The first layer



- ① Drill 3.2*150mm 2pcs
- ② Drill 4.6*150mm 2pcs
- ③ Pointed Reduction Forceps 230mm 1pcs
- ④ Template 12*12mm 1pcs
- ⑤ Template 12*180mm 1pcs
- ⑥ Template 12*120mm 1pcs
- ⑦ Depth Gauges 0-90mm 1pcs
- ⑧ Retractor 18mm 1pcs
- ⑨ Retractor 42mm 1pcs

The second layer



- ① Hollow Reamer 8mm 1pcs
- ② Countersink drill 8mm 1pcs
- ③ Screw Extractor 1pcs
- ④ Screw Tap M4x0.5mm 1pcs
- ⑤ Screw Tap A6.8mm 1pcs
- ⑥ Drill Bits Guide Sleeve 3.2mm 1pcs
- ⑦ Drill Bits Guide Sleeve 4.5mm/6.5mm 1pcs
- ⑧ Hex Screwdriver 3.5mm 1pcs
- ⑨ Periosteal Elevator 15mm square head 1pcs
- ⑩ Periosteal Elevator 12mm Round head 1pcs
- ⑪ Screw Holder 1pcs

The third layer



- ⑪ Curved Reduction Forceps 210mm 1pcs
- ⑫ Self-centering Forceps 260mm 2pcs
- ⑬ Plate Bending Forces 2*1



Orthopedic Kirschner Wire Cutter Pin Cutter Set

Item code: SET-1019 (Material: Stainless steel)

Wire Passer 1pc

Wire Passer 1pc

Bending Iron For Kirschner Wires 1pc

Wire Tightener With Handle and two pegs 1pc

Wire Tightener Forceps 0.8/1.0/1.2mm 1pc

Pin Holding Forceps Tungsten Carbide Insters 1pc

Wire Cutter , Tungsten Carbide Insters 160mm Length 1pc

Wire Cutter , Tungsten Carbide Insters 230mm Length 1pc

Flat-Nosed Parallel Pliers 160mm Length 1pc

Front End ,wire cutting plier,upper to 2.5mm 200mm length 1pc

wire cutter ,1.5/2.0 /3.0mm, 200mm length 1pc

sterilizer case 1pcs



Orthopedic AO Locking Instrument Set (AO)

Item code: SET-1006 (Material: Stainless steel)

1 Drill Bit Stopper

1 Drill Bit Stopper Spanner

2 Drill Bit AO (1.8mm/2.5mm)

1 Screw Drill Guide 1.8mm

1 Locking Drill Guide Ø1.8mm

1 Drill Guide 1.8mm/2.5mm

1 AO Quick Coupling Handle

1 Depth Gauge 30mm

1 Screw Holder

1 AO Quick Coupling Torx Head Screw Driver T10

2 Plate Bending Wrench

1 Implants Box

1 Tool Box



Orthopedic DHS & DCS locking plate Instrument Kit (DHS & DCS)

Item code: SET-1023 (Material: Stainless steel)

1. T-handle Quick Coupling 1pcs	6.Tap Cancellous 6.5mm 1pcs	11.Threaded K-wire $\Phi 2.5 \times 225\text{mm}$ 2pcs
2.Tap Cortical 4.5mm 1pcs	7.Drill Bit $\Phi 4.5 \times 150\text{mm}$ 2pcs	12.DHS/DCS Impactor Large 1pcs
3.Double Drill Sleeve ($\Phi 4.5/\Phi 6.5$) 1pcs	8.Drill Bit $\Phi 3.2 \times 150\text{mm}$ 2pcs	13.Depth Gauge(0-90mm) 1pcs
4.Double Drill Sleeve($\Phi 4.5/\Phi 3.2$) 1pcs	9.Lag Screw Depth Measuring Device 1pcs	14.DHS/DCS Impactor Small 1pcs
5.Neutral and Load Drill Guide $\Phi 2.5$ 1pcs	10.Tap Cancellous 12mm 1pcs	15.DHS/DCS Wrench, Purple Sleeve 1pcs
16.DHS/DCS Wrench, Golden Sleeve 1pcs	17.Screwdriver Hexagonal 3.5mm 1pcs	18.DCS Angle Guide 95 Degree 1pcs
19.DHS Angle Guier 135 degree 1pcs	20.DHS Reamer 1pcs	21. DCS Reamer 1pcs
22. sterilizer case 1pcs		



Orthopedic Mini Fragment Instrument Kit

Item code: SET-1024 (Material: Stainless steel)

1. Screw Holding Forceps 1pc	8.Elevator Double 3mm 1pc	15.Reduction Forceps Curved 1pc
2. Tap HA2.0mm 1pc	9.Elevator Double 5mm 1pc	16.Reduction Forceps Teethed 1pc
3.Countersink Drill 1pc	10. Skin Retractor 2pc	17.Plate Bending Forceps 1pc
4.Drill Bit 1.5mm 2pc	11.Hohmann 3pc	18.Bone Rongeurs Double 1pc
5. Double Guide 1.5-2.0mm 1pc	12.Tip Pull Hook 1pc	19.Wire Cutter 1pc
6. Depth Gauge 0-30mm 1pc	13. Partial threaded Kirschner wires 1.5mm 2pc	20.Hex Screw Driver 1.5mm 1pc
7. Plate Bending Forceps 1pc	14.Reduction Forceps with point 1pc	21.Square Screw Driver 1.5mm 1pc
22.Screw Box 1pc	23. sterilizer case 1pcs	



Orthopedic Spinal Lower Instrument Kit

Item code: SET-1025 (Material: Stainless steel)

1. Rod Bender 1pc	5. Star Screwdriver T25 2pc	9. Drill Bits 4.4mm 2pc
2. Compression Forceps 1pc	6. Rod Holding Forceps 1pc	10. Depth Gauge 0-120mm 1pc
3. Distractor Clamp 1pc	7. Rod Bender Left/Right 1set	11. Guide Sleeve 4.1mm 2pc
4. Star Screwdriver T20 2pc	8. Drill Bits 3.9mm 2pc	12. Guide Sleeve 5.0mm 1pc
13. Sterilizer case 1pc		



Orthopedic ACL/plc set Reconstruction Knee Arthroscopy Instruments (ACL/plc)

Item code: SET-1026 (Material: Stainless steel/aluminum)

1. 2.5 Cruciate Ligament Sight 1pcs	7. Femoral Offset Guider 6mm 1pcs	13. Carilage Awl 1pcs
2. Anterior Cruciate Ligament Point-to-Point Locator 1pcs	8. Femoral Offset Guider 7mm 1pcs	14. Tendon Extractor 7mm 1pcs
3. Posterior Cruciate Ligament Tibia Locator 1pcs	9. Drill Protec 1pcs	15. cannulated drill bit for Tibia (5,6,7,8,8.5,9,9.5mm) 7pcs
4. Posterior Cruciate Ligament Femoral Positioner 1pcs	10. Probe Depth 1pcs	16. cannulated drill bit for Femur (5,6,7,8,9,10mm) 6pcs
5. Bone File Straight 1pcs	11. Probe Depth Gauge 1pcs	17. Perforated guide needle 2pcs
6. Bone File Curved 1pcs	12. Tendon opening measurer 1pcs	18. sterilizer case

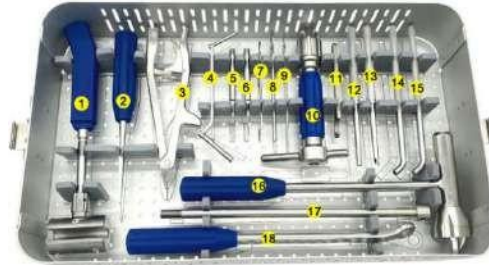

Orthopedic Elastic Stable Intramedullary Nailing Kit

Item code: SET-1027 (Material: Stainless steel/Silica gel)

1.Hammer 1pc	7. Double Drill Sleeve 3.2/4.5mm 1pc	13. Elastic Nail Inserter 1pc
2.AWL 1pc	8. End Cup Inserter Small 1pc	14. Standard Tamp 1pc
3.Locking Pliers 1pc	9. End Cup Inserter Large 1pc	15. Standard Tamp 1pc
4.Hammer Guider 1pc	10. Drill Bit $\phi 2.7 \times 115\text{mm}$ 1pc	16. Bender 1pc
5.Cutter 1pc	11. Drill Bit $\phi 3.2 \times 150\text{mm}$ 1pc	17. Bender 1pc
6.Cutter 1pc	12. Drill Bit $\phi 4.5 \times 150\text{mm}$ 1pc	18. sterilizer case

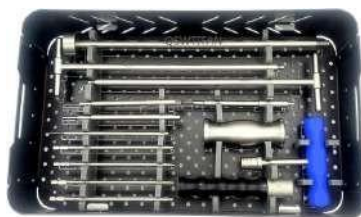

Broken Screw Intramedullary Nail Removal Instrument Set

Item code: SET-1028 (Material: Stainless steel/Silica gel)

Number	Quantity	Number	Quantity
1	1	18	1
2	1	19	1
3	1	20	1
4	1	21	1
5	1	22	1
6	1	23	1
7	1	24	1
8	1	25	1
9	1	26	1

10	Connecting rod 7	1	27	Quick Coupling Handle	1
11	Connecting rod 8	1	28	Hexagonal Screwdriver SW	1
12	Connecting rod 9	1	29	Hexagonal Screwdriver SW	1
13	Connecting rod 10	1	30	Hexagonal Screwdriver SW	1
14	Connecting rod 11	1	31	Hexagonal Screwdriver SW	1
15	Connecting rod 12	1	32	Hexagonal Screwdriver SW	1
16	Connecting rod 13	1	33	Slide hammer	1
17	L Wrench	1	34	Box	1
34 pieces in total					

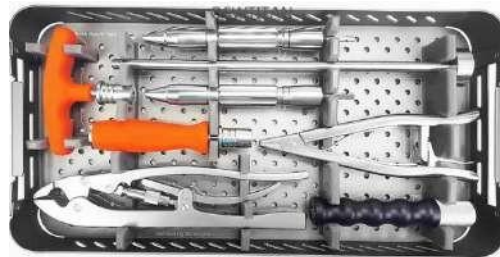
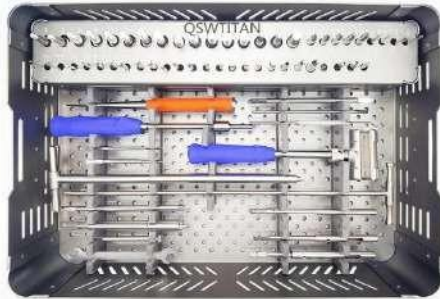

Orthopedic Broken Screw Removal Spinal Lower Instrument Kit

Item code: SET-1029 (Material: Stainless steel/Silica gel)

Number		Quantity	Number		Quantity
1	Connecting rod tap 1	1	41	hex screwdriver SW4.0	1
2	Connecting rod tap 2	1	42	hex screwdriver SW4.5	1
3	Connecting rod tap 3	1	43	hex screwdriver SW5.0	1
4	Connecting rod 1	1	44	hex screwdriver SW5.5	1
5	Connecting rod 2	1	45	Star Screwdriver T6	1
6	Connecting rod 3	1	46	Star Screwdriver T7	1
7	Connecting rod 4	1	47	Star Screwdriver T8	1
8	Connecting rod 5	1	48	Star Screwdriver T9	1
9	Connecting rod 6	1	49	Star Screwdriver T10	1
10	Connecting rod 7	1	50	Star Screwdriver T15	1
11	Connecting rod 8	1	51	Star Screwdriver T20	1
12	Connecting rod 9	1	52	Star Screwdriver T25	1
13	Connecting rod 10	1	53	Star Screwdriver T30	1
14	Connecting rod 11	1	54	Hollow Saw for broken screw 2.0	1
15	Connecting rod 12	1	55	Hollow Saw for broken screw 2.7	1
16	Connecting rod 13	1	56	Hollow Saw for broken screw 4.0	1
17	L Wrench	1	57	Hollow Saw for broken screw 5.0	1
18	Hex Wrench	1	58	Hollow Saw for broken screw 6.5	1
19	Open Wrench	1	59	Hollow Saw for broken screw 8.0	1
20	Impacting&Extracting Device	1	60	Trephine 4.0mm	1
21	PFNA Screwdriver Left	1	61	Trephine 5.0mm	1
22	PFNA Screwdriver Right	1	62	Trephine 6.5mm	1

23	Blades Screw Extractor	1	63	straight screwdriver 3.0	1
24	Slide hammer	1	64	straight screwdriver 6.0	1
25	Movable hammer	1	65	Square screwdriver 1.2	1
26	Hexagonal Screwdriver SW 7.0	1	66	Square screwdriver 1.5	1
27	Hexagonal Screwdriver SW 8.0	1	67	cross screwdriver	1
28	Impacting&Extracting Device L=400	1	68	Pin extractor (for spine)	1
29	Strength Pliers	1	69	triangle knife	1
30	Box	1	70	Round bone knife	1
31	ail slip extractor 2.0	1	71	round hook	1
32	ail slip extractor 2.5	1	72	Broken nail removal pliers	1
33	ail slip extractor 2.7	1	73	Tungsten drill bit	1
34	ail slip extractor 3.5	1	74	Tungsten drill bit	1
35	ail slip extractor 4.0	1	75	Tungsten drill bit	1
36	hex screwdriver SW1.5	1	76	Quick release handle	1
37	hex screwdriver SW2.0	1	77	Screw Extractor 4.5mm	1
38	hex screwdriver SW2.5	1	78	Screw Extractor 3.5mm	1
39	hex screwdriver SW3.0	1	79	T-shaped quick release handle	1
40	hex screwdriver SW3.5	1			

79 pieces in total



Orthopedic Rib Plate Instrument Set

Item code: SET-1030 (Material: Stainless steel)

1. Reduction Forceps Double Large	4. Reduction Forceps Single	7. Rib Plate Cutter
2. Reduction Forceps Curved	5. Periosteal Elevator 9mm	8. Plate Insert Forceps
3. Reduction Forceps Double Small	6. Periosteal Elevator 12mm	9. Sterilizer case



Elastic Stable Intramedullary Nailing instruments Kit

Item code: SET-1033 (Material: Stainless steel)

1. Hammer 1pc	7. Double Drill Sleeve 3.2/4.5mm 1pc	13. Elastic Nail Inserter 1pc
2. AWL 1pc	8. End Cup Inserter Small 1pc	14. Standard Tamp 1pc
3. Locking Pliers 1pc	9. End Cup Inserter Large 1pc	15. Standard Tamp 1pc
4. Hammer Guider 1pc	10. Drill Bit $\varnothing 2.7 \times 115\text{mm}$ 1pc	16. Bender 1pc
5. Cutter 1pc	11. Drill Bit $\varnothing 3.2 \times 150\text{mm}$ 1pc	17. Bender 1pc
6. Cutter 1pc	12. Drill Bit $\varnothing 4.5 \times 150\text{mm}$ 1pc	18. sterilizer Box 1pc



ALPS Mini Titanium Locking Plate System 1.1 1.6mm

Item code: SET-1031/SET-1032 (Material: Stainless steel/titanium)



<ul style="list-style-type: none"> Drill Bit 0.8mm 3pcs Drill Bit 1.1mm 3pcs Locking Drill Guide 1.1mm 1pcs Double Drill Guide 0.8/1.1mm 1pcs Cross Head Screw Driver 1.1mm 1pcs Depth Gauge 0-30mm 1pcs 1.1mm T Plates 5hole 1pcs 1.1mm T Plates 6hole 1pcs 1.1mm T Plates 7hole 1pcs 1.1mm T Plates 8hole 1pcs Bending Irons 3.5/4.2mm 1pcs ALPS3.5 T2 Locking plate (2+5) hole 1pcs ALPS3.5 T3 Locking plate (3+5) hole 1pcs ALPS4.2 T2 Locking plate (2+5) hole 1pcs ALPS4.2 T3 Locking plate (3+5) hole 1pcs 1.1mm Cuttable Malleable Plate 30 hole 90mm 1pcs 1.1mm Cuttable Plate 27hole 90mm 	<ul style="list-style-type: none"> ALPS3.5 Locking plate 30hole 135mm 1pcs ALPS4.2 Locking plate 26hole 130mm 1pcs 1.1mm Double T Cuttable Malleable Plate 32hole 90mm 1pcs C1.1*4mm Cortical Screws Self-Tapping 8pcs C1.1*5mm Cortical Screws Self-Tapping 8pcs C1.1*6mm Cortical Screws Self-Tapping 8pcs C1.1*7mm Cortical Screws Self-Tapping 8pcs C1.1*8mm Cortical Screws Self-Tapping 8pcs C1.1*9mm Cortical Screws Self-Tapping 8pcs C1.1*10mm Cortical Screws Self-Tapping 8pcs C1.1*12mm Cortical Screws Self-Tapping 8pcs B1.6*4mm Locking Screw 8pcs B1.6*5mm Locking Screw 8pcs B1.6*6mm Locking Screw 8pcs B1.6*7mm Locking Screw 8pcs B1.6*8mm Locking Screw 8pcs B1.6*10mm Locking Screw 8pcs ALPSmini Implants Case 1pcs
--	--

SET-1032 set

ALPS Mini Titanium Locking Plate System

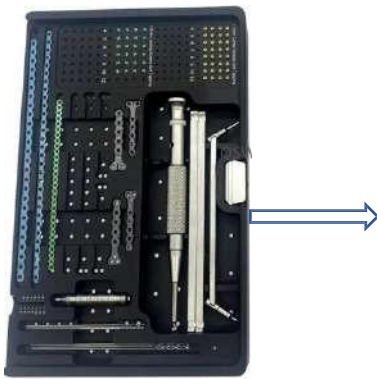

SET-1031 set



- | | |
|--|---|
| Drill Bit 0.8mm 3pcs | C1.1*5mm Cortical Screws Self-Tapping 4pcs |
| Drill Bit 1.1mm 3pcs | C1.1*6mm Cortical Screws Self-Tapping 4pcs |
| Locking Drill Guide 1.1mm 1pcs | C1.1*7mm Cortical Screws Self-Tapping 4pcs |
| Double Drill Guide 0.8/1.1mm 1pcs | C1.1*8mm Cortical Screws Self-Tapping 4pcs |
| Cross Head Screw Driver 1.1mm 1pcs | C1.1*9mm Cortical Screws Self-Tapping 4pcs |
| Bending Irons 3.5/4.2mm 1pcs | C1.1*10mm Cortical Screws Self-Tapping 4pcs |
| ALPS3.5 T2 Locking plate (2+5) hole 1pcs | C1.1*12mm Cortical Screws Self-Tapping 4pcs |
| ALPS3.5 T3 Locking plate (3+5) hole 1pcs | B1.6*4mm Locking Screw 4pcs |
| ALPS4.2 T2 Locking plate (2+5) hole 1pcs | B1.6*5mm Locking Screw 4pcs |
| ALPS4.2 T3 Locking plate (3+5) hole 1pcs | B1.6*6mm Locking Screw 4pcs |
| 1.1mm Cuttable Malleable Plate 30hole 1pcs | B1.6*7mm Locking Screw 4pcs |
| ALPS3.5 Locking plate 30hole 135mm 1pcs | B1.6*8mm Locking Screw 4pcs |
| ALPS4.2 Locking plate 26hole 130mm 1pcs | B1.6*10mm Locking Screw 4pcs |
| C1.1*4mm Cortical Screws Self-Tapping 4pcs | ALPSmini Implants Case 1pcs |

ALPS Mini Titanium Locking Plate System

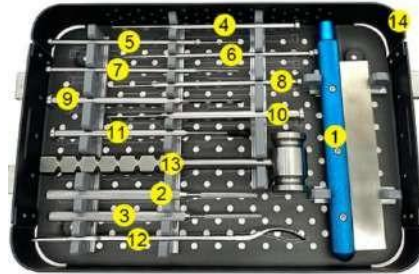

Trochlea Rectangular Sulcoplasty Instruments Kit

Item code: SET-1037 (Material: Stainless steel)

- | | |
|----------------------------------|--------------------------------|
| ① Sulcoplasty Bone Saw 1pcs | ⑧ Chisel 8mm 1pcs |
| ② Trochlea Rasp Small 3.5mm 1pcs | ⑨ Chisel 10mm 1pcs |
| ③ Trochlea Rasp Mini 4.0mm 1pcs | ⑩ Chisel 12mm 1pcs |
| ④ Chisel 2mm 1pcs | ⑪ Chisel 15mm 1pcs |
| ⑤ Chisel 3mm 1pcs | ⑫ Double Rasps 1pcs |
| ⑥ Chisel 4mm 1pcs | ⑬ Orthopedic Mallet 270g 1pcs |
| ⑦ Chisel 6mm 1pcs | ⑭ Sterilization Container 1pcs |



ACL/pcl Reconstruction Knee Arthroscopy Instruments (ACL C-Type)

Item code: SET-1007 (Material: Stainless steel)

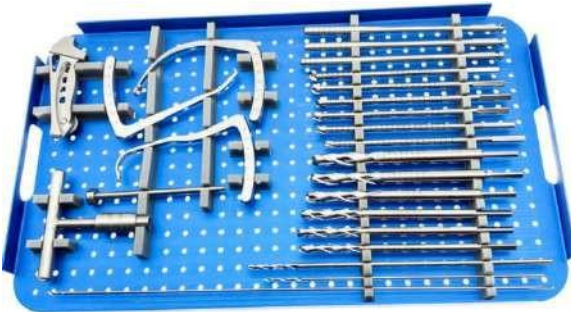

The first-layer



The Second-layer



The third-layer



Soft Tissue Surgical Instruments Kit

Item code: SET-1034

Material: Stainless steel

NO with Tray sterilizer box

Soft Tissue Surgical Instruments Kit

Item code: SET-1036 (Material: Stainless steel)

With Tray sterilizer box



- | | |
|--|--|
| ① Halsted Mosquito Straight 160mm 1pcs | ⑨ 1*2 teeth Dissecting Forceps 125mm 1pcs |
| ② Halsted Mosquito Curvved 160mm 1pcs | ⑩ Towel Clamp 115mm 4pcs |
| ③ Halsted Mosquito Straight 125mm 1pcs | ⑪ Operating Scissors Blunt 140mm 1pcs |
| ④ Halsted Mosquito Curvved 125mm 1pcs | ⑫ Dressing Blunt 140mm 1pcs |
| ⑤ Uterine hook Animal Ovariectomy 8mm 1pcs | ⑬ Needle Holder With TC. 150mm 1pcs |
| ⑥ Blade Handle 3# 1pcs | ⑭ Blunt Scissors Straight 140mm 1pcs |
| ⑦ Blade Handle 4# 1pcs | ⑮ Alliss Tissue Forceps 160mm 2pcs |
| ⑧ Seerrated Dissecting Forceps 125mm 1pcs | ⑯ Sterilization Case 235mm*155mm*45mm 1pcs |

Soft Tissue Surgical Instruments Kit

Item code: SET-1035 (Material: Stainless steel)

With Tray sterilizer box



- | | |
|--|--|
| ① Halsted Mosquito Straight 160mm 1pcs | ⑨ 1*2 teeth Dissecting Forceps 125mm 1pcs |
| ② Halsted Mosquito Curved 160mm 1pcs | ⑩ Towel Clamp 115mm 4pcs |
| ③ Halsted Mosquito Straight 125mm 1pcs | ⑪ Operating Scissors Blunt 140mm 1pcs |
| ④ Halsted Mosquito Curved 125mm 1pcs | ⑫ Dressing Blunt 140mm 1pcs |
| ⑤ Uterine hook Animal Ovariectomy 8mm 1pcs | ⑬ Needle Holder With TC 150mm 1pcs |
| ⑥ Blade Handle 3# 1pcs | ⑭ Blunt Scissors Straight 140mm 1pcs |
| ⑦ Blade Handle 4# 1pcs | ⑮ Allis Tissue Forceps 160mm 2pcs |
| ⑧ Seerrated Dissecting Forceps 125mm 1pcs | ⑯ 5/5 ⑰ Sterilization Case 235mm*155mm*35mm 1pcs |

Animal Ovary Ligation Sterilization set

Item code: SET-1038 (Material: Stainless steel)

With Tray sterilizer box



Number		Quantity	Number		Quantity
1	Towel Clamp 95mm	1	15	Halsted Mosquito Straight 140mm	1
2	Towel Clamp 115mm	1	16	Halsted Mosquito Straight 160mm	1
3	Towel Clamp 135mm	1	17	Halsted Mosquito Curved 125mm	1
4	Towel Clamp 155mm	1	18	Halsted Mosquito Curved 140mm	1
5	Spay Snook With Ball 6mm	1	19	Halsted Mosquito Curved 160mm	1
6	Spay Snook With Ball 8mm	1	20	Needle Holder With TC 140mm	1
7	Spay Snook With Ball 10mm	1	21	Operating Scissors Blunt 140mm	1
8	Spay Snook With Ball 12mm	1	22	Blunt Scissors Straight 140mm	1
9	Dissecting Forceps 1.0 Teeth	1	23	Operating Scissors Blunt 140mm	1
10	Dissecting Forceps 1.0 platform	1	24	Ligation Fixed Forceps Curved 160mm	1
11	Blade Handle 3#	1	25	Ligation Fixed Forceps Curved 140mm	1
12	Blade Handle 4#	1	26	Ligation Fixed Forceps Straight 160mm	1
13	Alliss Tissue Forceps 160mm	2	27	Ligation Fixed Forceps Straight 140mm	1
14	Halsted Mosquito Straight 125mm	1	28	Sterilization Case 235mm*155mm*35mm	1



Pelvic Reconstruction Bone Plate set

Item code: SET-1040 Total 3 layer

Material: Stainless steel

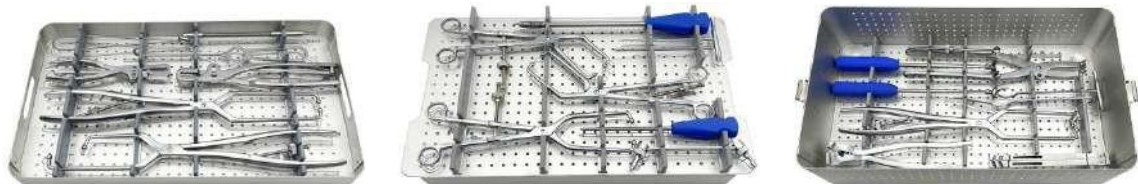

Number		Quantity
1	Soft Drill Guide (Soft HOOK)	1
2	Flexible Drill Bit	1
3	Bone Hook	1
4	Bone Holding Forcep 250mm	1
5	Bone Holding Forcep 200mm	1
6	Pelvic Reduction Forcep 420mm	1
7	Pelvic Reduction Forcep with High-low Ball-tipped 415mm	1



Number		Quantity
8	Reduction Forcep Straight 295mm	1
9	Reduction Forcep Curved 295mm	1
10	Reduction Forcep Curved 295mm	1
11	Universal Screw Driver SW2.5	1
12	Universal Hex Screwdriver SW2.5	1
13	Drill Guider $\Phi 2.5 \times 170$ mm	1
14	Drill Bit $\Phi 2.5 \times 150$ mm	2
15	Screw Tap HA3.5	1



Number		Quantity
16	Ball Tips(Curved) /Ball Tips(Flat)	1
17	Plate Bending Iron Left/Right	1
18	T-handle Bone Hook	1
19	Retractor	1
20	Plate Bender	1
21	Acetgubulum Reduction forceps	1
22	Pelvic Reduction Forcep with 3 Ball-tipped 400mm	1

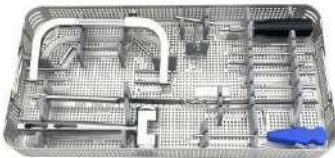
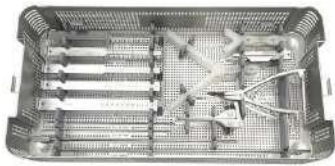

Tibial Osteotomy HTO Surgical Instrument Kit HTO

Item code: SET-1041 Total 2 layer

Material: Stainless steel

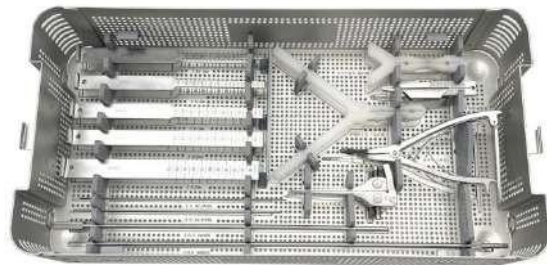
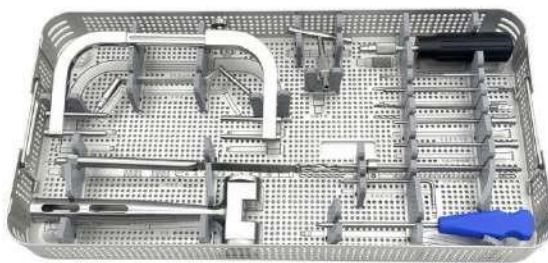

- | | |
|---------------------------------------|---|
| ① Torque screwdriver 4.0N/M 1pcs | ⑦ Drill bits 4.2*200mm 2pcs |
| ② Depth gauge 100mm 1pcs | ⑧ 4.5mm A0 tap 1pcs
3.5mm hex driver A0 1pcs |
| ③ Alignment Rod Holder 1pcs | ⑨ Hex wrench 1pcs |
| ④ Drill guide 4.5-6.5 1pcs | ⑩ T-shaped AO handle 1pcs |
| ⑤ Inside hexs crewdriver SW3.5mm 1pcs | ⑪ 2.0mm K-wire guide 1pcs |
| ⑥ Bone mallet 1pcs | ⑫ 4.3*230mm A0 bits 2pcs
4.3mm stopper 1pcs |

- | | |
|--|---|
| ⑬ Tibia clamp small 1pcs | ⑱ Alignment Rod 1pcs |
| ⑭ Femur clamp large 1pcs | ⑲ Alignment Rod 1pcs |
| ⑮ Osteotome (6, 10, 15, 20, 25mm) 4pcs | ⑳ Tibial Plate Osteotomy angle ruler 1pcs |
| ⑯ K-wire needle 2.5*250mm 4pcs | ㉑ Height ruler 1pcs |
| ⑰ Distraction Plier 1pcs | ㉒ Sterilization case (aluminum) 1pcs |



Cable Synthes Passer Wire Tightener Forceps Set

Item code: SET-1042 Total 2-layer

Material: Stainless steel

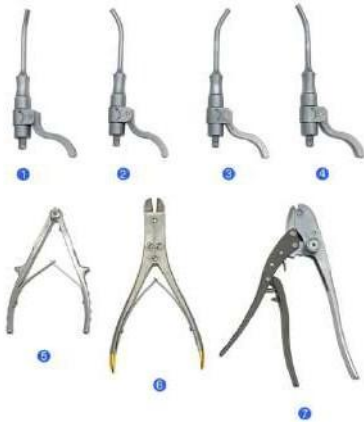
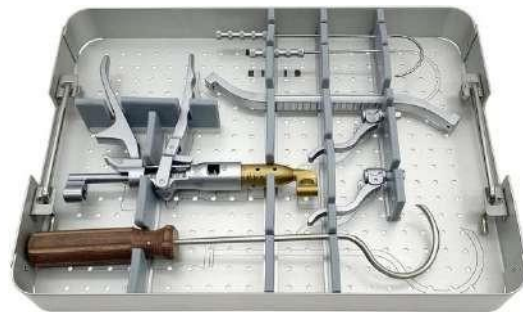

Contain :

- | | |
|------------------------|--------------------------------|
| ① Threader Φ 1.3 | ⑧ Threader Curved |
| ② Threader Φ 1.3 | ⑨ Bone Spicule Bender |
| ③ Threader Φ 1.8 | ⑩ Threader Curved |
| ④ Threader Φ 1.8 | ⑪ Threader Straight |
| ⑤ Wire Cutting pliers | ⑫ Compression forceps Gun-Type |
| ⑥ Titanium Cage Cutter | ⑬ Threader Φ 1.3 |
| ⑦ Compression forceps | ⑭ Threader Φ 1.8 |



Cable Synthes Passer Wire Tightener Forceps Set

Item code: SET-1060-1 Total 2 layer

Material: Stainless steel

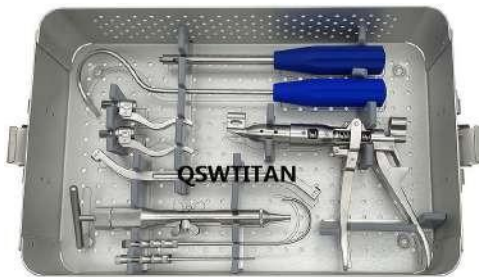

The First Layer

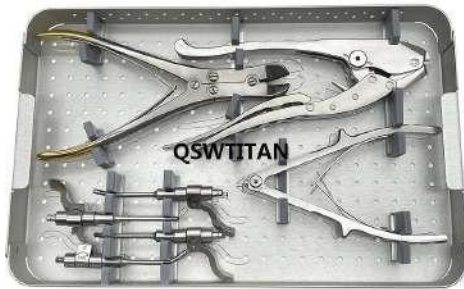

The Second Layer



Number		Quantity
1	Threader	2
2	Threader Straight	1
3	Threader Curved	1
4	Cable Passer curved	1
5	Cable Passer straight	1
6	Bone Spicule Bender Ø2.0 Ø2.5	1
7	Compression forceps Gun-Type	1
8	Cable Tensioner	1

Number		Quantity
9	Attachment Bit	4
10	Pressure cable lock	4
11	Flat connector crimper	1
12	Spicule/cutter	1
13	Cable cutter	1

Achilles Tendon Ligment Repair Kit

Item code: SET-1043 Material:

Stainless steel



Number		Quantity	Number		Quantity
1	Wire Guide	2	6	Threading Guide Pin	2
2	Drill Sight	1	7	Achilles Tendon Holding Forceps	1
3	Threader-small	1	8	Needle Holder	1
4	Threader-curved	1	9	Quick Couping Handle	1
5	Threader-Straight	1	10	Thimble	1



UBE Spine instrument set

UBE

Item code: SET-1047 Total 2 layer

Material: Stainless steel

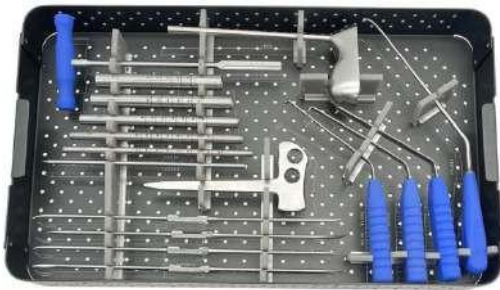

Number	Quantity	Number	Quantity	Number	Quantity	Number	Quantity
1	1	10	1	18	1	25	1
2	1	11	1	19	1	26	1
3	1	12	1	20	1	27	1
4	1	13	1	21	1	28	1
5	1	14	1	22	1	29	1
6	1	15	1	23	1	30	1
7	1	16	1	24	1	31	1
8	1	17	1				
9	1						



Internal Fixation AO Broken Nail Removal Set (A0)

Item code: SET-1046 Material:

Stainless steel

Hexagon

Ao interface



Size:
SW1.5 SW2.0 SW 2.5 SW3.0
SW3.5 SW4.0 SW4.5 SW5.0



Size: SW3.5 3.0mm 3.5mm 1.2mm 1.5mm

Star screwdriver Plum Blossom



Size: T4 T6 T7 T8 T10 T15 T20 T25



Ao interface



Size: 4.0 6.0 8.0 SW2.5 SW3.5



Mini Fragment Finger Palm Bone Locking Plate Set Mini

Item code: SET-1051 Material:

Stainless steel



Includes:

- ① Tap HA2.7
- ② Guider 2.0/2.7
- ③ Drill Bit 2.0*80mm
- ④ Quick Coupling Screwdriver Hex (HA2.7)
- ⑤ Tap HA1.5
- ⑥ Guider 1.1/1.5
- ⑦ Drill Bit 1.1*80mm
- ⑧ Quick Coupling Screwdriver Hex (HA2.0)
- ⑨ Tap HA2.0
- ⑩ Guider 1.5/2.0
- ⑪ Drill Bit 1.5*80mm
- ⑫ Quick Coupling Screwdriver Hex (HA1.5)
- ⑬ Bent-tip Reduction Forcep
- ⑭ Pointed-tip Reduction Forcep
- ⑮ Shape-made Forcep
- ⑯ T-handle Quick Coupling

- ⑰ Wire Cutter
- ⑱ Plate-bended Forcep
- ⑲ Plate-hold Forceps
- ⑳ Straight Handle Quick Coupling
- ㉑ Countersink 4.0
- ㉒ T-04-13 Dissector 3mm 5mm
- ㉓ Depth Gague 0-40mm
- ㉔ Sharp Hook
- ㉕ Screw Forcep
- ㉖ Bending Iron
- ㉗ Skin Retractor
- ㉘ Retractors 1*3
- ㉙ Aluminum Box

Finger Mini locking Instruments Kit

1.5-2.0



Micro Finger Palm Bone Locking Plate Set Micro

Item code: SET-1049 Material:

Stainless steel



The first layer



- ① 2* Threaded Drill Guide $\Phi 1.1$
- ② 2* Threaded Drill Guide $\Phi 1.5$
- ③ Screw tapping HA1.5 *2 , HCL1.5 *2
- ④ Screw tapping HA2.0 *2 , HC2.0 *2
- ⑤ 1* Bone Countersink Drill 3.5



The Second layer



- ⑥ 3* Kirschner wires pin 1.0
- ⑦ 3* Threaded pin 1.0
- ⑧ 2* Drill bit 1.5*110
- ⑨ 2* Drill bit 1.1*110
- ⑩ 2* Hex screwdriver SW2.0
- ⑪ 2* Hex screwdriver SW1.5
- ⑫ 4* Star screwdriver T6
- ⑬ 1* Torque Limiting Handle 0.4N.M
- ⑭ 1* Quick contact handle
- ⑮ 1* AO Quick contact handle
- ⑯ Nail holder sleeve 1.5/2.0
- ⑰ 1* Depth Gauge L30
- ⑱ 1* Double Drill Bits Guider $\Phi 1.5-\Phi 2.0$
- ⑲ 1* Double Drill Bits Guider $\Phi 1.1-\Phi 1.5$
- ⑳ 1* Sterilizer case

Finger Mini locking Instrument kit

2.5-2.7



Micro Finger Palm Bone Locking Plate Set Micro

Item code: SET-1048 Material:

Stainless steel



The First Layer



- ① 2* Threaded Drill Guide 1.8
- ② 2* Threaded Drill Guide 2.0
- ③ Screw tapping HA2.5 *2, HC2.5 *2
- ④ Screw tapping HA2.7 *2, HC2.7 *2
- ⑤ 2* Bone Countersink Drill 3.5 4



The second Layer



- ⑤ 3* Kirschner wires pin 1.0
- ⑦ 3* Threaded pin 1.0
- ⑧ 2* Drill bit 1.8*110
- ⑨ 2* Drill bit 2.0*110
- ⑩ 1* Hex screwdriver AO 2.0
- ⑪ 1* Hex screwdriver AO 2.5
- ⑫ 2* Star screwdriver T8
- ⑬ 1* Torque Limiting Handle 0.6N.M
- ⑭ 1* Quick contact handle
- ⑮ 1* AO Quick contact handle
- ⑯ Nail holder sleeve 2.5/2.7
- ⑰ 1* Depth Gauge L30
- ⑱ 1* Double Drill Bits Guider $\Phi 1.8-\Phi 2.5$
- ⑲ 1* Double Drill Bits Guider $\Phi 2.0-\Phi 2.7$
- ⑳ 1* Sterilizer case



2.7 Osteotomy Locking Plate Instrument Set 2.7

Item code: SET-1050

Material: Stainless steel



The first layer



The First layer

Number	Product list	Quantity
1	Screw box	1
2	Bone holding Forceps Large	1
3	Ratchet Handle Quick Coupling 0.8N.m	1
4	Bone Reduction Forceps Small	1
5	Osteotomy locator	1
6	Quick Coupling Handle	1
7	Triangle Locating plate 90°/150°/40°	1
8	Triangle Locating plate 100°/90°/30°	1
9	Triangle Locating plate 80°/170°/30°	1



The Second layer



Number	Product list	Quantity
10	Drill Positioning Stopper	1
11	Locking Screws tapping 30mm	1
12	Star screwdriver T8	2
13	Lock screw guide Ø21	1
14	Aiming module locator Ø27	1
15	Kirschner wires Pins Ø2.0x65	3
16	Broken guide pin Ø2.0x230	3
17	Threaded K wires Pins Ø2.0x230	3
18	Depth Gauge 0-50	1
19	Aiming module Ø27	1
20	Star screwdriver T3.0	1
21	Guide Depth Gauge 0-50	1
22	Double Drill guide Ø21 Ø27	1
23	A/D Drill bits Ø2.1/60 mm	1
24	Driver case	1



4.0/5.0 Paediatrics Osteotomy Locking Plate Instrument Kit

4.0/5.0

Item code: SET-1052 Material

Stainless steel

The First layer

Number	Product list	Quantity
1	Screw holder SW2.5	1
2	Screw holder SW3.5	1
3	Hex driver SW2.5x25mm	1
4	Hex driver SW3.5x15mm	1
5	Bone Reduction Forceps large	1
6	Screwdriver SW2.5	1
7	Screwdriver SW3.5	1
8	Aiming module 4.0	1
9	Aiming module 5.0	1
10	Torque Handle Quick Coupling 4.0Nm	1
11	Torque Handle Quick Coupling 1.5Nm	1

The Second layer

Number	Product list	Quantity
12	Reset sleeve 4.3/2.2	2
13	Hex driver SW3.5x10mm	1
14	Hex driver SW2.5x75mm	1
15	Threaded Drill Guide 4.0-5.0	2
16	Aiming module locator	1
17	Triangle Locating plate 80°/70°/30°	1
18	Triangle Locating plate 100°/60°/20°	1
19	Triangle Locating plate 80°/50°/40°	1
20	Bone holding Forceps Large	1
21	Osteotomy locator	1
22	Double Drill guide Ø3.5-Ø5.0	1
23	Double Drill guide Ø3.0-Ø4.0	1
24	AO Quick Coupling Handle	1

The third layer

Number	Product list	Quantity
25	Sterilizer case	1
26	Drill Positioning Stopper Ø3.2	1
27	Drill Positioning Stopper Ø4.3	1
28	Bone tapping HA.G.0 150mm	1
29	Bone tapping HA.A.0 95mm	1
30	LCP guide sleeve Ø4.3	3
31	LCP guide sleeve Ø5.2	3
32	Wrench SW2.5	3
33	Depth Gauge 0-100	1
34	Depth Gauge 0-60	1
35	Depth Gauge 4.0-5.0	1
36	Drill bits Ø4.3/2.8mm	2
37	Kirschner wires Pins Ø2.5x200mm	8
38	Threaded K wires Pins Ø2.0x150mm	4
39	Drill bits Ø3.2°/180mm	2
40	Drill bits Ø3.0°/180mm	2
41	Drill bits Ø3.5°/150mm	2



Orthopedic DCP LCP Locking Plates Instruments Kit

Item code: SET-1060 Material

Stainless steel



The first Layer

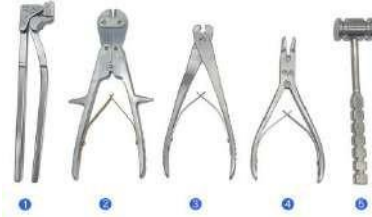

Number		Quantity
1	多功能弯钳 AO Multifunctional Bender	1
2	小弯剪 Kirschner wire scissors	1
3	钢丝剪 Steel Wire Cutter	1
4	双头弯剪 Steel Wire Cutter	1
5	骨锤200g Bone hammer 200g	1



The Second Layer



Number		Quantity
6	撑开器 Weilauer Retractor	2
7	小弯持板器 Plate Rod-Holding Forces Small	2
8	AO快速手柄 AO Quick Coupling Handle	1
9	夹持器 KEEN Bone Holding Forceps	1
10	绞丝钳 Cerclage Wire Twister	1
11	尖头圆齿钳 Pointed Bone Reduction Forcep 135mm	1
12	尖头圆齿钳 Pointed Bone Reduction Forcep 160mm	1
13	空心手钻 Hand Drill Cannulated	1
14	钥匙 Key	1



The third Layer



Number		Quantity
15	手持骨锯 Bone saw hand	1
16	骨锯 Bone saw	1
17	骨板 Plate	3
18	钢丝 0.3 steel Wire 2.5m	1
19	AO丝圈 AO trap 1.5	1
20	AO丝圈 AO trap 2.0	1
21	AO丝圈 AO trap 2.4	1
22	AO丝圈 AO trap 2.7	1
23	Φ1.0 克氏针10支 Kirschner wire Φ1.0 245mm	10
24	钢丝圈 Wire circle	1
25	骨垫 osteotome 30mm	1
26	克氏针入骨 Kirschner wire punch	1
27	克氏针弯钳 Kirschner wire bender Φ1.2-Φ2.5	1
28	骨垫小号 Hirschman Retractor small	1
29	骨垫中号 Hirschman Retractor Medium	1
30	骨垫大号 Hirschman Retractor Big	1
31	皮肤牵引器 Skin retractor Hook	2
32	骨垫 Bone Fix Ø5.0	1
33	骨垫 Bone Fix Ø5.0	1
34	骨垫升降器 Mini double end periosteal Elevator 5mm	1
	器械包 Denker Case	1



Shoulder Arthroscopy suture hook lasso

Item code: SET-1053

Material: Stainless steel /Aluminum

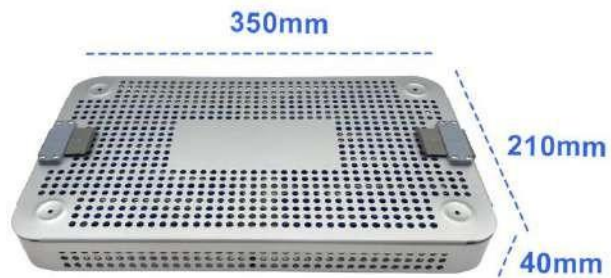
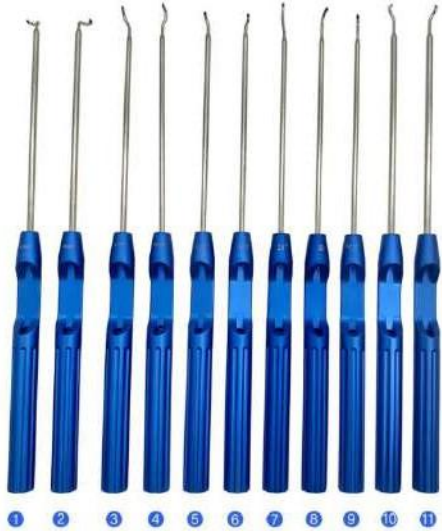

Number		Quantity
1	Cuff Suture- Left 90°	1
2	Cuff Suture- Right 90°	1
3	Cuff Suture- Left 45°	1
4	Cuff Suture- Right 45°	1
5	Cuff Suture- Left 25°	1
6	Cuff Suture- Right 25°	1
7	Cuff Suture- Crescent 25°	1
8	Cuff Suture- Straight	1
9	Cuff Suture- Crescent 12.5°	1
10	Cuff Suture- Left Curved	1
11	Cuff Suture- Right Curved	1



Orthopedic AO LC-DCP Instruments Kit AO

Item code: SET-1054 Material:

Stainless steel



The First layer



Number		Quantity
1	Sterilization Case	1
2	Reduction Forceps Small	1
3	Bone Rongeurs	1
4	End Cutting Forceps	1
5	Kirschner Wire Scissors	1
6	Self Centering Reduction Forceps Small	1
7	Self Centering Reduction Forceps Very Small	1



The second layer



Number		Quantity	Number		Quantity
8	Bending Irons 1 Pair	1	21	AO QC Taps 2.7mm	1
9	Bending Irons 1 Pair	1	22	AO QC Taps 3.5mm	1
10	3.1mm Drill Bit	1	23	AO QC Countersink #4	1
11	1.5mm Drill Bit	1	24	AO QC Countersink #6	1
12	1.8mm Drill Bit	1	25	Depth gauge 0-30mm	1
13	2.0mm Drill Bit	1	26	AO T Tap Handle	1
14	2.4mm Drill Bit	1	27	Plum/Star screwdriver T6	1
15	3.5mm Drill Bit	1	28	Plum/Star screwdriver T10	1
16	2.5mm Drill Bit	1	29	Small Bone Holding Forceps 5mm	1
17	2.7mm Drill Bit	1	30	Small Bone Holding Forceps 2mm	1
18	AO QC Taps 1.5mm	1	31	Small Fragment Forceps Pointed 35mm	1
19	AO QC Taps 2.0mm	1	32	Medium Fragment Forceps Pointed 25mm	1
20	AO QC Taps 2.4mm	1	33	Depth gauge 0-50mm	1



The third layer



Number		Quantity
34	Westman Retractor	2
35	AO Type Periosteal Elevator Curved Edge 8mm	1
36	Double-head Hooks Sharp Teeth	2
37	Hand drill Aluminum handle	1
38	Key	1
39	Cerclage Wire Tackster/ Tightening Cutter	1
40	K Wire/Small Pin Punch 1.5-2.5mm	1
41	K Wire Bender	1
42	Double End Periosteal Elevator 5mm	1
43	Wire Passer Diameter 20mm	1
44	Double-head Hooks Sharp Teeth	1
45	Hohman Retractor 5mm	1
46	Hohman Retractor 8mm	1
47	Hohman Retractor Broad 20mm	1
48	Hohman Retractor Broad 20mm	1



The Four layer



Number		Quantity
49	Drill bits guider sleeve Double 2.5-3.5	1
50	Drill bits guider sleeve Double 2.0-2.5	1
51	Drill bits guider sleeve Double 1.8-2.4	1
52	Drill bits guider sleeve Double 1.5-2.0	1
53	Drill bits guider sleeve Double 1.1-1.5	1
54	Load And Neutral Drill Guides Sleeve 2.5/3.5mm	1
55	Load And Neutral Drill Guides Sleeve 2.0/2.7mm	1
56	Load And Neutral Drill Guides Sleeve 1.5/2.0mm	1
57	Load And Neutral Drill Guides Sleeve 1.8/2.4mm	1
58	Bone plate molding diaphragm	1
59	Bone plate molding diaphragm	1
60	Bone plate molding diaphragm	2



TPLO Plate Jig Kit Set

TPLO

Item code: SET-1055 Material

Stainless steel



The first layer



Number	Quantity	Number	Quantity
1	1	13	1
2	1	14	1
3	1	15	1
4	1	16	1
5	1	17	1
6	1	18	1
7	1	19	1
8	1	20	1
9	1	21	1
10	1	22	1
11	1	23	1
12	1	24	1

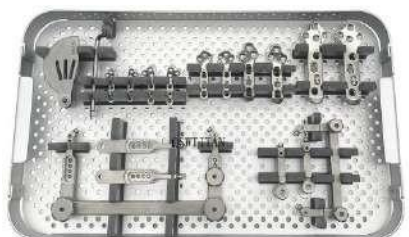

The Second layer



Number	Quantity
25	1
26	0
27	1
28	2
29	1
30	1
31	1
32	10
33	10
34	10
35	10
36	10
37	1

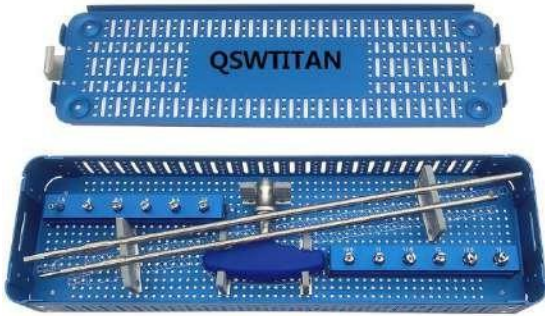

Orthopedic Flexiable Reamer set

Item code: SET-1061 Material

Stainless steel

Set Contain

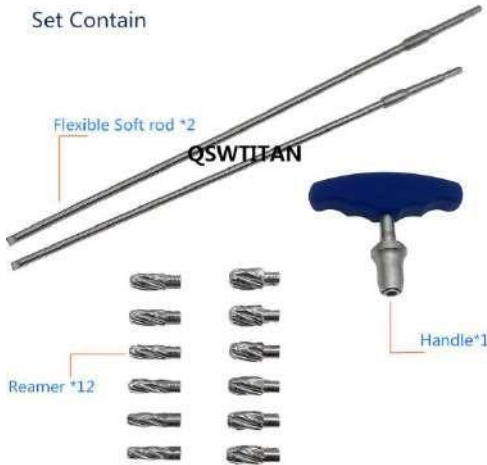

Reamer

QSWTITAN
490mm

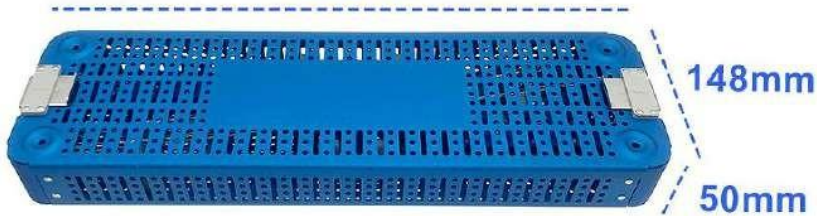



Orthopedic Acetabulum Reamer set

Item code: SET-1057 Material

Stainless steel

Acetabular Reamer shaft



300mm

QSWTITAN



Acetabulum Reamer



Match Sterilizing Case



Implants TTA Cage Tibial Tuberosity Rapid Set TTA

Item code: SET-1056 Material

Stainless steel



The First Layer



The Second Layer



2.4mm cortacil screws 10/12/14/16/18 10 ea
TTA Cages C3-10, C3-13, C4.5-12, C4.5-15, C6-16, C6-19, C7.5-16, C7.5-19



Code	Product name	QTY
1	TTA Cages C3-10,C3-13,C4.5-12,C4.5-15,C6-16,C6-19,C7.5-16,C7.5-19	8
2	2.4mm cortacil screws 10/12/14/16/18 10ea	50
3	AO QC Handle	1
4	AO QC T10 Star Screwdriver	1
5	Depth gauge 35mm	1
6	L-Shaped Limiter	2
7	TTA Pliers	1
8	Plate Bender	1
9	Retractor	1
10	2.5/3.0mm Position Pin	2
11	1.0mm Position Pin	1
12	Sterilization Box	1

MediTools Orthopedic Power Tools



The image shows the TPLO SAW kit, including the main handpiece, a power source, a battery, and several interchangeable cutting heads of various sizes and shapes, along with a hex key.

TPLO SAW

For bone cutting and repair surgery

[VIEW MORE >](#)

BONE DRILL

Used for orthopedic trauma surgery cutting, drilling, nail or screw fixation etc.

[VIEW MORE >](#)



The image displays the Bone Drill kit, featuring a handpiece, a power source, a battery, and a variety of drill bits and accessories, including a carrying case.

OSCILLATING SAW

Used for bone surgery, reaming, cutting, grinding etc.

[VIEW MORE >](#)



The image shows the Oscillating Saw kit, which includes a handpiece, a power source, a battery, and several oscillating blades and accessories.

目录

- (1) S series Bone drill/ Canulated drill Oscillating saw/Cranial drill)
- (2) S series Multifunctional Power System.....
- (3) G series Bone drill/ Canulated drill Oscillating saw/Cranial drill.....
- (4) N series Multifunctional Power System.....
- (5) Micro small Bone drill/ Canulated drill / Oscillating saw
- (6) MICRO Multifunctional Power System
- (7) TPLO SAW and blade
- (8) Battery and accessories
- (9) Sterilizer box.....
- (10) Saw blade and custom
- (11) rui jin Orthopedic power tool

(Product introduction -S series power tool)



	Item ID	Speed	Range	Accessories
Bone Drill	DHGZ-1	0-1200 rpm	0.8-8mm	1 Motor handlepiece, 2 batteries, 1 charger, 1 key, 1 sterilization ring, 1 Aluminum case or 1 Sterilizer case



	Item ID	Speed	Range	Accessories
Cannulated Drill	DHKGZ-1	0-1000 rpm	0.8-8mm	1 Motor handlepiece, 2 batteries, 1 charger, 1 key, 1 sterilization ring, 1 Aluminum case or 1 Sterilizer case



	Item ID	Speed	Range	Accessories
Cannulated Drill	DJ-K-R02	0-1000 rpm	0.8-8mm	1 Motor handlepiece, 2 batteries, 1 charger, 1 key, 1 sterilization ring, 1 Aluminum case or 1 Sterilizer case



- ① P Handlepiece
- ② P Sterilization channel
- ③ P Key
- ④ P Batteries
- ⑤ P Charger
- ⑥ P Aluminum case

	Item ID	Speed	Range	Accessories
Cannulated Drill	DJ-K01	0-1000 rpm	0.8-8mm	1 Motor handlepiece, 2 batteries, 1 charger, 1 key, 1 sterilization ring, 1 Aluminum case or 1 Sterilizer case

(Product introduction -S series power tool)



	Item ID	Speed	Accessories
Oscillating Saw	DHBJ-1	0-18000 cpm	1 Motor handlepiece, 3 blades, 2 batteries, 1 charger, 1 key, 1 sterilization ring, 1 Aluminum case or 1 Sterilizer case



	Item ID	Speed	Accessories
Oscillating Saw	DJ-O	0-18000 cpm	1 Motor handlepiece, 3 blades, 2 batteries, 1 charger, 1 key, 1 sterilization ring, 1 Aluminum case or 1 Sterilizer case



	Item ID	Speed	Accessories
Reciprocating Saw	DHWFJ-1	0-14000 cpm	1 Motor handlepiece, 3 blades, 2 batteries, 1 charger, 1 key, 1 sterilization ring, 1 Aluminum case or 1 Sterilizer case



	Item ID	Speed	Accessories
Sternum Saw	DJ-S	0-14000 cpm	1 Motor handlepiece, 3 blades, 2 batteries, 1 charger, 1 key, 1 sterilization ring, 1 Aluminum case or 1 Sterilizer case

(Product introduction -S series power tool)



	Item ID	Speed	Accessories
Craniotomy drill	DJ-C	0-1000 rpm	1 Motor handlepiece, 2 batteries, 1 charger, 1 sterilization ring, 1 Aluminum case or 1 Sterilizer case



	Item ID	Speed	Accessories
Craniotomy Mill	DJ-M	0-36000 rpm	1 Motor handlepiece, 2 batteries, 1 blade, 1 charger, 1 sterilization ring, 1 Aluminum case or 1 Sterilizer case



	Item ID	Speed	Accessories
Bone Drill	QS-J07	0-1200 rpm	1 Motor handlepiece, 2 batteries, 1 key, 1 charger, 1 sterilization ring, 1 Aluminum case or 1 Sterilizer case



	Item ID	Speed	Accessories
Cannulated Drill	QS-J08	0-1000 rpm	1 Motor handlepiece, 2 batteries, 1 key, 1 charger, 1 sterilization ring, 1 Aluminum case or 1 Sterilizer case

(Product introduction -S series power tool)



	Item ID	Speed	Accessories
Oscillating Saw	QS-J10	0-18000 cpm	1 Motor handlepiece, 2 batteries, 1 charger, 3 blade, 1 sterilization ring, 1 Aluminum case or 1 Sterilizer case

Craniotomy Drill



	Item ID	Speed	Accessories
Craniotomy Drill	QS-J11	≥800 rpm	1 Motor handlepiece, 2 batteries, 1 charger, 3 heads, 1 sterilization ring, 1 Aluminum case or 1 Sterilizer case



	Item ID	Speed	Accessories
Craniotomy Mill	QS-J12	0-36000 rpm	1 Motor handlepiece, 2 batteries, 1 charger, 1 blade, 1 sterilization ring, 1 Aluminum case or 1 Sterilizer case



	Item ID	Speed	Accessories
Sternum Saw	QS-J13	0-14000 cpm	1 Motor handlepiece, 2 batteries, 1 charger, 3 blade, 1 sterilization ring, 1 Aluminum case or 1 Sterilizer case

(Product introduction -S series power tool)

Multifunctional Power Drill saw System

Multiple functions in one, wide application range. Quick replacement of components, convenient and fast, suitable for closing Section, trauma, neurosurgery, intracardiac surgery, fitness The components used include hollow drill assembly and Kirschner wire set Parts, bone drill assembly, slow drill assembly, swing saw assembly, Craniotomy milling assembly, reciprocating saw assembly, sternum saw group. Craniotomy drill assembly.



ID: YTM-100-B



Multifunctional motor (handpiece)

Bone Drill attachment

Diameter of drill chuck:0.8-8mm
Speed:0-1200rpm



Acetabular reaming attachment

Diameter of drill chuck: 1.0-8mm
Speed:0-300rpm



K wire attachment

Diameter of drill chuck: 0.8-2mm
Speed:0-1200rpm



K wire attachment

Diameter of drill chuck:1.8-3.2mm
Speed:0-1200rpm



Oscillating saw attachment

With 3pcs Blades
Speed frequency: 18000cpm



Canulated Drill attachment

Diameter of drill chuck:0.8-8mm
Speed:0-1000rpm



Cranial drill attachment

Speed:0-800rpm



Cranial mill attachment

Diameter of drill chuck: 1.0-8mm
Speed:0-300rpm



Reciprocating saw attachment

With 2pcs Blades
Speed frequency:14000cpm



Sternum saw attachment

Speed frequency:14000cpm



TPLO attachment

Not include blade
speed frequency: 18000cpm



(Product introduction -G series power tool)



	Item ID	colour	Speed	Range	Accessories
Bone Drill	YTGZ-01	Silver/ black	0-1200 rpm	0.8-8mm	1 Motor handlepiece, 2 batteries, 1 charger, 1 key, 1 sterilization ring,
	YTGZ-02	Can choose			1 Aluminum case or 1 Sterilizer case



	Item ID	colour	Speed	Range	Accessories
Bone Drill	QSDZ-03S	Silver/ black	0-1200 rpm	0.8-8mm	1 Motor handlepiece, 2 batteries, 1 charger, 1 key, 1 sterilization ring,
	QSDZ-03B	Can choose			1 Aluminum case or 1 Sterilizer case



	Item ID	colour	Speed	Range	Accessories
Cannulated drill	YTKXZ-01	Silver/ black	0-1000 rpm	0.8-8mm	1 Motor handlepiece, 2 batteries, 1 charger, 1 key, 1 sterilization ring,
	YTKXZ-02	Can choose			1 Aluminum case or 1 Sterilizer case



	Item ID	colour	Speed	Range	Accessories
Cannulated drill	QSDZ-01S	Silver/ black	0-1000 rpm	0.8-8mm	1 Motor handlepiece, 2 batteries, 1 charger, 1 key, 1 sterilization ring,
	QSDZ-01B	Can choose			1 Aluminum case or 1 Sterilizer case

(Product introduction -G series power tool)



摆据	Item ID	colour	Speed	Accessories
Oscillating Saw	OSDZ-01S	Silver/ black	0-18000 cpm	1 Motor handlepiece, 2 batteries, 1 charger, 1 key, 1 sterilization ring,
	OSDZ-01B	Can choose		1 Aluminum case or 1 Sterilizer case



摆据	Item ID	colour	Speed	Accessories
Oscillating Saw	OSDZ-02S	Silver/ black	0-18000 cpm	1 Motor handlepiece, 2 batteries, 1 charger, 1 key, 1 sterilization ring,
	OSDZ-02B	Can choose		1 Aluminum case or 1 Sterilizer case

Tip: Oscillating Saw has 3 interfaces to choose, as follow:



(Product introduction -G series power tool)



(Reciprocating Saw)



(Sternum Saw)



(Craniotomy Drill)



(Craniotomy mill)

(Product introduction -G series power tool)



Aluminum case packing

Sterilization case packing

BONE DRILL

bone drill	Speed	Range	accessories
QSDZ-03S - Silver QSDZ-03B - Black	0-1200rpm	0.8-8mm	2 batteries, 1 charger, 1key , 1 sterilization ring, Aluminum case or Sterilizer case



Cannulated Drill

Cannulated Drill	Speed	Range	Accessories
QSDZ-01S - Silver QSDZ-01B - Black	0-800rpm	0.8-8mm	2 batteries, 1 charger, 1key , 1 sterilization ring, Aluminum case or Sterilizer case (can choose)



Oscillating Saw

Oscillating Saw	Speed	Interface	Accessories
QSDZ-02S - Silver QSDZ-02B - Black	0-16700cpm	AO (can choose)	2 batteries, 1 charger, 3 blades , 1 sterilization ring, Aluminum case or Sterilizer case (can choose)

(Product introduction –G series power tool)



	Item ID	colour	Speed	Accessories
Oscillating Saw	WK-BSAW-2battery	Silver	0-18000 cpm	1 Motor handlepiece, 2 batteries, 1 charger, 3 blades, 1 sterilization ring, 1 Aluminum case or 1 paper case or 1 Sterilizer case



	Item ID	colour	Speed	Range	Accessories
Bone Drill	WK-KX-2-2batt	Silver	0-1000 rpm	0.6-8mm	1 Motor handlepiece, 2 batteries, 1 charger, 3 blades, 1 sterilization ring, 1 Aluminum case or 1 paper case or 1 Sterilizer case



- ① 1" Handpiece
- ② 1" Sterilizing channel
- ③ 1" Key
- ④ 2" Batteries
- ⑤ 1" Charger



	Item ID	colour	Speed	Range	Accessories
Bone Drill	WK-KX-1-2batt	Silver	0-1000 rpm	0.6-8mm	1 Motor handlepiece, 2 batteries, 1 charger, 1 key, 1 sterilization ring, 1 Aluminum case or 1 paper case or 1 Sterilizer case

Multifunctional Power System

(Product introduction –N series power tool)

Multiple functions in one, wide application range. Quick replacement of components, convenient and fast, suitable for closing Section, trauma, neurosurgery, intracardiac surgery, fitness The components used include hollow drill assembly and Kirschner wire set Parts, bone drill assembly, slow drill assembly, swing saw assembly, Craniotomy milling assembly, reciprocating saw assembly, sternum saw group. Craniotomy drill assembly.



ID: YTM-100



Multifunctional motor (handlepiece)

Bone Drill attachment

Diameter of drill chuck: 0.8-8mm
Speed: 0-1200rpm



Acetabular reaming attachment

Diameter of drill chuck: 1.0-8mm
Speed: 0-300rpm



K wire attachment

Diameter of drill chuck: 0.8-2mm
Speed: 0-1200rpm



K wire attachment

Diameter of drill chuck: 1.8-3.2mm
Speed: 0-1200rpm



Oscillating saw attachment

With 3pcs Blades
Speed frequency: 18000cpm



Canulated Drill attachment

Diameter of drill chuck: 0.8-8mm
Speed: 0-1000rpm



Cranial drill attachment

Speed: 0-800rpm



Cranial mill attachment

Diameter of drill chuck: 1.0-8mm
Speed: 0-300rpm



Reciprocating saw attachment

With 2pcs Blades
Speed frequency: 14000cpm



Sternum saw attachment

Speed frequency: 14000cpm



TPLO attachment

Not include blade
speed frequency: 18000cpm



(Product introduction –Micro/small series power tool)

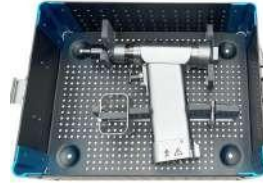

	Item ID	colour	Speed	Range	Accessories
Micro Bone Drill	YTXGZ-03	Silver	0-1200 rpm	0.4-4mm	1 Motor handlepiece, 2 batteries, 1 charger, 1 key, 1 sterilization ring, 1 Aluminum case or 1 Sterilizer case



- ① 1* Handpiece
- ② 1* Key
- ③ 1* Sterilizing channel
- ④ 2* Batteries
- ⑤ 1* Charger

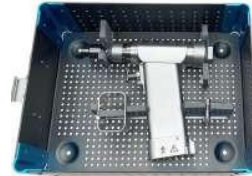

	Item ID	colour	Speed	Range	Accessories
Micro Bone Drill	WK-KX-4	Silver	0-1200 rpm	0.4-4mm	1 Motor handlepiece, 2 batteries, 1 charger, 1 key, 1 sterilization ring, 1 Aluminum case or 1 Sterilizer case



	Item ID	colour	Speed	Range	Accessories
Micro Bone Drill	FQS-JF1	Silver	0-1200 rpm	0.4-4mm	1 Motor handlepiece, 2 batteries, 1 charger, 1 key, 1 sterilization ring, 1 Aluminum case or 1 Sterilizer case

(Product introduction –Micro/small series power tool)



Micro Cannulated Drill



	Item ID	colour	Speed	Range	Accessories
Micro Cannulated Drill	JPXX-02	Silver	0-1200 rpm	0.4-4mm	1 Motor handlepiece, 2 batteries, 1 charger, 1 key, 1 sterilization ring, 1 Aluminum case or 1 Sterilizer case



	Item ID	colour	Speed	Range	Accessories
Micro Cannulated Drill	YTXK-1	Silver	0-1200 rpm	0.4-4mm	1 Motor handlepiece, 2 batteries, 1 charger, 1 key, 1 sterilization ring, 1 Aluminum case or 1 Sterilizer case



	Item ID	colour	Speed	Range	Accessories
Micro Cannulated Drill	QSDZ-05S	Silver	0-1200 rpm	0.4-4mm	1 Motor handlepiece, 2 batteries, 1 charger, 1 key, 1 sterilization ring, 1 Aluminum case or 1 Sterilizer case



	Item ID	colour	Speed	Range	Accessories
Micro Cannulated Drill	WK-KX-3	Silver	0-1200 rpm	0.4-4mm	1 Motor handlepiece, 2 batteries, 1 charger, 1 key, 1 sterilization ring, 1 Paper case or 1 Sterilizer case

(Product introduction –Micro/small series power tool)



	Item ID	colour	Speed	Use	Accessories
Micro Oscillating Saw	JPXBJ-01	Silver	0-18000 Cpm	trauma surgery	1 Motor handlepiece, 2 batteries, 1 charger, 3 blades, 1 sterilization ring, 1 Paper case or 1 Sterilizer case



	Item ID	colour	Speed	Use	Accessories
Micro Oscillating Saw	QSDZ-04S	Silver	0-18000 Cpm	trauma surgery	1 Motor handlepiece, 2 batteries, 1 charger, 3 blades, 1 sterilization ring, 1 Paper case or 1 Sterilizer case



	Item ID	colour	Speed	Use	Accessories
Micro Oscillating Saw	QS-J4	black	0-18000 Cpm	trauma surgery	1 Motor handlepiece, 2 batteries, 1 charger, 1 key, 1 sterilization ring, 1 Aluminum case or 1 Sterilizer case

MICRO Multifunctional Power System

A variety of functions in one, a wide range of use. Quick attachment replacement, convenient, more economical, Can achieve a multi-purpose machine, suitable for small joints, trauma, neurosurgery, intracardiac surgery, applicable attachment include Small Kirschner wire attachment , small bone drill attachment, small AO drill attachment, small swing saw attachment.



ID: QSDZ-06S



Micro Multifunctional motor (handlepiece)

You can choose any of the following attachments match the multi-function handle to complete the operation according to your surgical needs

	Name	Speed
	AO drill attachment	0-1200rpm
	Oscillating saw Attachment With 3 blades	0-18000cpm
	Cannulated drill Attachment	0-1200rpm Range :0.6-3.2mm
	K-Wire Attachment	0-1200rpm Range :0.8-2mm



With sterilizer case



With Aluminum case

(Product introduction –TPLO SAW)



with Aluminum case

with sterilizer case

TPLO Saw

TPLO Saw	Speed	Voltage	Accessories	Blade size can choose
NS-6072	0-16000cpm	12v	2 batteries, 1 charger, 1key , 2 sterilization ring , 2 blades, Aluminum case or Sterilizer case (can choose)	8mm , 10mm , 12mm, 15mm, 18mm, 20mm 21mm, 24mm, 27mm, 30mm, 33mm



TPLO Saw

TPLO Saw	Speed	Voltage	Accessories	Blade size can choose
Tplo-N	0-16000cpm	12v	2 batteries, 1 charger, 1key , 2 sterilization ring , 2 blades, Aluminum case or Sterilizer case (can choose)	8mm , 10mm , 12mm, 15mm, 18mm, 20mm 21mm, 24mm, 27mm, 30mm, 33mm



TPLO Saw

TPLO Saw	Speed	Voltage	Accessories	Blade size can choose
NS-6072-R	0-16000cpm	12v	2 batteries, 1 charger, 1key , 2 sterilization ring , 2 blades, Aluminum case or Sterilizer case (can choose)	8mm , 10mm , 12mm, 15mm, 18mm, 20mm 21mm, 24mm, 27mm, 30mm, 33mm

(Product introduction –TPLO SAW)

TPLO saw blades (TPLO)



Size:

8mm, 10mm, 12mm,
15mm, 18mm, 20mm, 21mm
24mm, 27mm, 30mm, 33mm

TPLO saw blades size can choose:

8mm	10mm	12mm	15mm	18mm	20mm
21mm	24mm	27mm	30mm	33mm	



(Electric drill accessories series)



G series battery B

GB-DC13.2V	1800mAh
GB-DC14.4V	1800mAh



G series battery S

GB-DC13.2V	1800mAh
GB-DC14.4V	1800mAh



G series H Series E series Charger

G-CDQ 7.2V-14.4V



E series H series battery

HS-DC7.2V	1800mAh
-----------	---------



G series H series N series
Battery disinfection channel

GXDTD



G Series N Series D series s series
Chuck key



Drill chuck

0.8-8mm
0.6-4mm

(Electric drill accessories series)



STERILIZATION CASE



(Electric drill/Saw sterilizer case)

Sterilizer Case



Item code: GKX22



can be use for TPLO Saw ,etc



Item code: GKX23



can be use for big electric drill , etc



Item code: GKX24



can be use for small/ micro electric drill , etc



Item code: GKX30

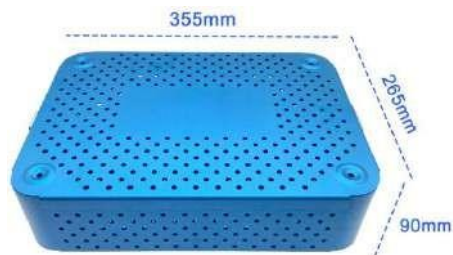

can be use for big electric drill/saw , etc

(Electric drill/Saw sterilizer case)

Sterilizer Case



Item code: GKX25-RJ Single layer Size: 400*260*90
Suitable for single electric drill or multi-functional drill set(NM100/NM500)



Item code: GKX26-RJ Double layer Size: 330*270*150
Suitable for multi-functional drill set (NM100/NM500)

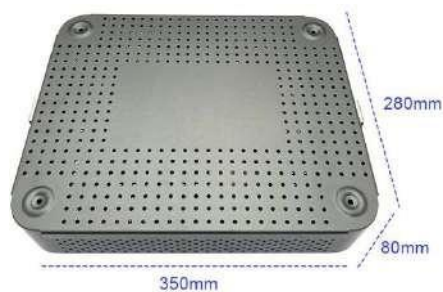

Item code: GKX25 Single layer Size : 350*280*80
Suitable for single electric drill or mirco multi-functional drill set.

(Electric drill/Saw sterilizer case)

Sterilizer Case



Item code: GKX27-RJ Size : 440*285*205
Suitable for ruijin E,S series double multifunctional electric drill



Item code: GKX27-RJ Size : 330*270*90 (Single layer)
Suitable for ruijin E,S series multifunctional electric drill,

(Electric saw accessories blades series)



Small /Micro Blade

Size: mm Size can be customized

Total Length	37	40	43	47.5	49	55	57	68
Effective length	22	25	29.5	31	39	40	50	
Width	5.5	7	8	9.5	13	14	15	24
Thickness	0.3	0.5	0.8					



**Large blade (universal)
blade**

Size :mm Size can be customized

1271189025	10987024	127987022	1271189022	101189022
121189024	121189019	101189013	1271189013	1012810022
1212810022	1012810013	08785013	58301005	58301006

(Electric saw accessories blades series)

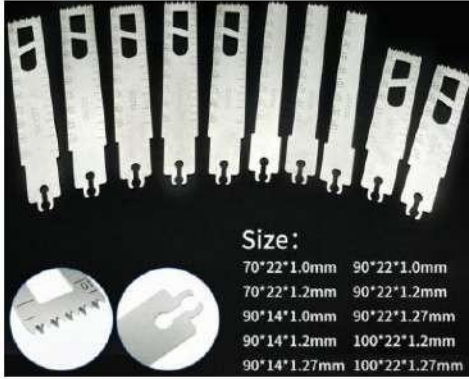

Size:
 70*22*1.0mm 90*22*1.0mm
 70*22*1.2mm 90*22*1.2mm
 90*14*1.0mm 90*22*1.27mm
 90*14*1.2mm 100*22*1.2mm
 90*14*1.27mm 100*22*1.27mm

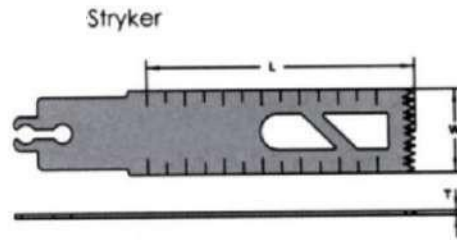

Size :mm Size can be customized

Effective length	70	90	100	110				
Width	14	18	22					
Thickness	0.7	0.8	0.9	1.0	1.2	1.27	1.37	



Size:
 70*22*1.0mm 50*22*1.0mm
 70*22*1.2mm 90*22*1.2mm
 90*14*1.0mm 100*22*1.2mm
 90*14*1.2mm 100*22*1.27mm



Size:
 25*7.5*0.5mm
 25*9.5*0.5mm
 35*7.5*0.5mm
 35*9.5*0.5mm
 50*16*0.8mm

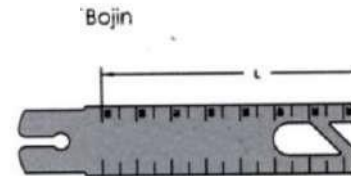

Size :mm Size can be customized

Effective length	25	35	50	70	90	100	
Width	7.5	9.5	14	16	22		
Thickness	0.5	0.8	1.0	1.2	1.27		

(Electric saw accessories blades series)

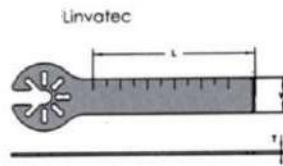

L	110	100	90	70
W	22	18	14	
T	1.37	1.27	1.2	1.0 0.9 0.8 0.7

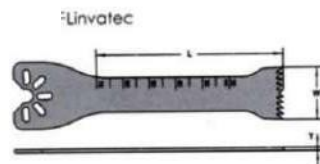

L	110	100	90	70
W	22	18	14	
T	1.37	1.27	1.2	1.0 0.9 0.8 0.7

Size : mm size can be customized

Size :mm Size can be customized

Effective length	70	90	100	110			
Width	14	18	22				
Thickness	0.7	0.8	0.9	1.0	1.2	1.27	1.37

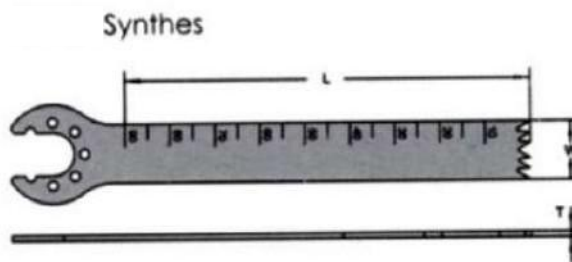

Size :mm Size can be customized

Effective length	70	90	100	110				
Width	14	18	22					
Thickness	0.3	0.5	0.7	0.8	0.9	1.0	1.2	1.27 1.37

(Electric saw accessories blades series)



Total length: 90mm
Working length: 70mm
Width: 13mm
Thickness: 0.7mm

往复锯片 Reciprocating saw blade



L	90	70	50
W	13	7	
T	1.0	0.8	

Reciprocating saw blade Size:
mm Size can be customized

Effective length	50	70	90
Width	13	7	
Thickness	1.0	0.8	0.7



Total length: 93mm
Working length: 70mm
Width: 13mm
Thickness: 0.7mm

Reciprocating saw blade
Size: mm Size can be customized

Effective length	50	70	90
Width	13	7	
Thickness	1.0	0.8	0.7



Reciprocating saw/Sternum saw blade
Size :mm Size can be customized

Effective length	50	70	90
Width	13	7	
Thickness	1.0	0.8	





Orthopedic Power Tools

WUHU RUIJIN MEDICAL
INSTRUMENT&DEVICE CO.,LTD



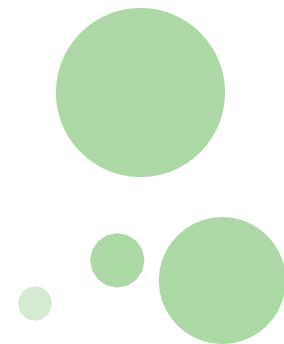

CONTENT

- **Power tool for big bone**
- **Power tool for small bone**
- **Orthopedic power tools**
- **Accessories**

Sterilization case for power tools

Order code
PJDB001

*Power tools excluded

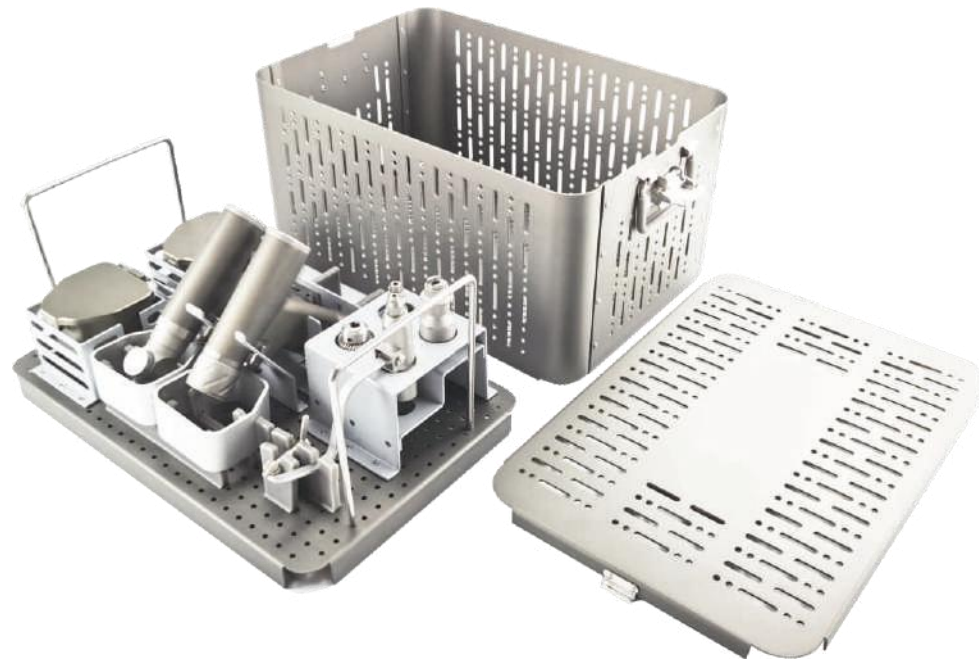

Order code
PJDB001-A

*Power tools excluded

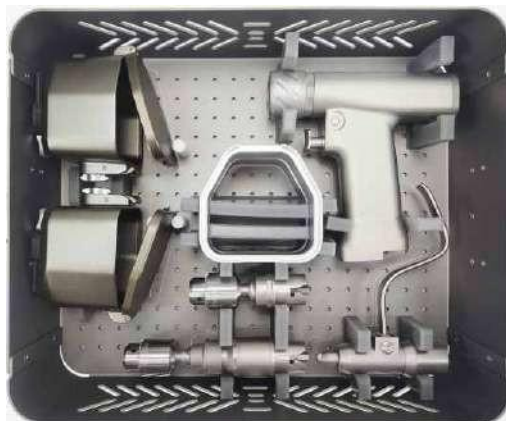

Order code
PJDB001-B

*Power tools excluded



Brushless Multifunctional Drill Handpiece

Order code
SM100



K Wire Adapter

Order Code	Gripping Range	Speed
SM1-6001	Φ0.8 - Φ2.0	0-1200rpm
SM1-6001	Φ1.5 - Φ3.2	0-1200rpm



Bone Drill Adapter



Order Code	Interface type	Speed
SM1-1001	Universal	0-1200rpm
SM1-1001	 Stryker	0-1200rpm
SM1-1001	AO Synthes	0-1200rpm



Acetabular Reaming Drill Adapter

Order Code	Interface type	Speed
SM1-3011	Universal	0-300rpm
SM1-3011	 Stryker	0-300rpm
SM1-3011	AO	0-300rpm



Order Code	Interface type	Speed
SM1-3011	 Johnson	0-300rpm
SM1-3011	 Hudson	0-300rpm
SM1-3011	 Aesculap	0-300rpm



Power tool for big bone

Power tool for big bone

RJ-PS
Sternum Saw

Order code	Speed
SS-3032	0-14000 cpm

RJ-PS
Oscillating Saw

Order code	Speed
SS-1011	0-18000 cpm

RJ-MP
Brushless Multifunctional
Drill Handpiece

Order code
SM100

RJ-PS
Reciprocating Saw

Order code	Speed
SS-3031	0-14000 cpm



Accessories



Accessory Description **Order code**

Battery PJDC0960



Charger PJCG006



Battery Sterilizing Box PJBB002



Battery Aseptic Transfer Kit PJXD006



Key For Drill Chuck PJYS002

Sterilization case for power tools

Order code
PJDB002

*Power tools excluded



Order code
PJDB002-A

Order code
PJDB002-B

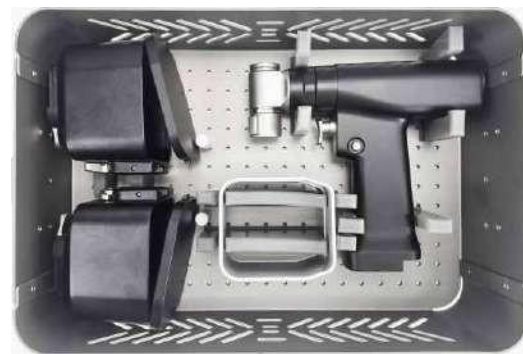
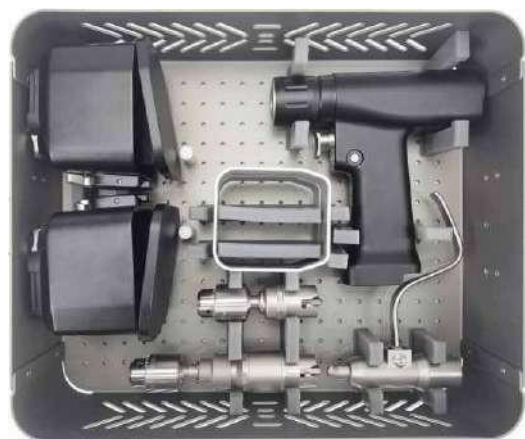

Brushless Multifunctional Drill Handpiece

Order code
EM100



K Wire Adapter

Order Code	Gripping Range	Speed
SM1-6001	Φ0.8 - Φ2.0	0-1200rpm
SM1-6001	Φ1.5 - Φ3.2	0-1200rpm



Bone Drill Adapter



Order Code	Interface type	Speed
SM1-1001	Universal	0-1200rpm
SM1-1001	 Stryker	0-1200rpm
SM1-1001	AO Synthes	0-1200rpm



Acetabular Reaming Drill Adapter

Order Code	Interface type	Speed
SM1-3011	Universal	0-300rpm
SM1-3011	 Stryker	0-300rpm
SM1-3011	AO	0-300rpm



Order Code	Interface type	Speed
SM1-3011	 Johnson	0-300rpm
SM1-3011	 Hudson	0-300rpm
SM1-3011	 Aesculap	0-300rpm



Power tool for big bone

Power tool for big bone

RJ-PS
Sternum Saw

Order code	Speed
ES-3032	0-14000 cpm

RJ-PS
Oscillating Saw

Order code	Speed
ES-1011	0-18000 cpm

RJ-MP
Brushless Multifunctional
Drill Handpiece





Order code
EM100

RJ-PS
Reciprocating Saw

Order code	Speed
ES-3031	0-14000 cpm



Accessories

Accessory Description	Order code
 Battery	PJDC1481
 Charger	PJCG005
 Battery Sterilizing Box	PJBB001
 Battery Aseptic Transfer Kit	PJXD004
 Key For Drill Chuck	PJYS002

Power tool for big bone

Power tool for big bone



RJ-MP
Multifunctional Handpiece

Order code
NM500

Sterilization case for power tools

Order code
PJDB003

*Power tools excluded

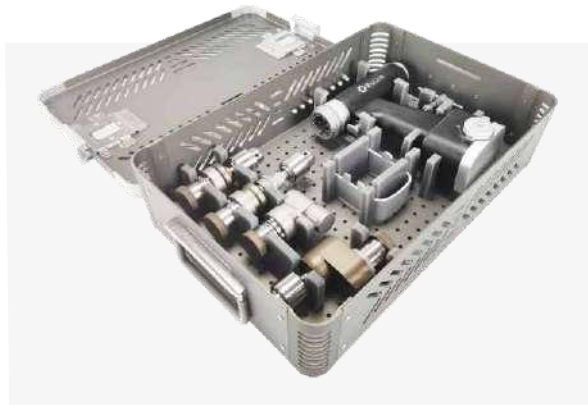

Order code
PJDB003-A

*Power tools excluded



Multiple functions in one, wide range of applications.

Quick replacement of adapters, convenient and speedy.

Suitable for joint, trauma, neurosurgery, and intracardiac surgery; Applicable components consist of canulate drill adapter, K wire adapter, bone drill adapter, acetabular reaming drill adapter, oscillating saw adapter, cranial drill adapter, reciprocating saw adapter, sternum saw adapter, TPLO saw adapter and cranial mill adapter.



NM5-2001
Canulate Drill Adapter

Item code	Gripping Range	Speed
MPN52001	0.8-7.9mm	0-1000 rpm
MPN52011	0.8-7.9mm	0-1000 rpm
MPN52021	0.8-7.9mm	0-1000 rpm



NM5-6001
K Wire Adapter

Item code	Gripping Range	Speed
MPN56001	0.8-2.0mm	0-1200rpm
MPN56002	1.5-3.2mm	0-1200rpm



NM5-1001
Bone Drill Adapter

Item code	Gripping Range	Speed
MPN51001	0.8-7.9mm	0-1200 rpm
MPN51021	/	0-1200 rpm



NM5-3011
Acetabular Reaming Drill Adapter

Item code	Gripping Range	Speed
MPN53011	1.0-8.1mm	0-300 rpm
MPN53021	1.0-8.1mm	0-300 rpm



NM5-S011
Oscillating Saw Adapter

Item code	Gripping Range	Speed
MPN5S011	/	0-18000 cpm



NM5-S091
Cranial Mill Adapter

Item code	Gripping Range	Speed
MPN5S091	/	0-36000 rpm



NM5-4011
Cranial Drill Adapter

Item code	Gripping Range	Speed
MPN54011	/	0-800 rpm



NM5-S032
Sternum Saw Adapter

Item code	Gripping Range	Speed
MPN5S032	/	0-14000 cpm



NM5-S031
Reciprocating Saw Adapter

Item code	Gripping Range	Speed
MPN5S031	/	0-14000 cpm



NM5-S071
TPLO Saw Adapter

Item code	Gripping Range	Speed
MPN5S071	/	0-16000 cpm



RJ-PD
Acetabular Reaming Drill

Order code	Speed
ND-3511	0-300 rpm

● Accept customization of various brands interface



Order code
PDN3511

Order code
PDN3521

Order code
PDN3531



RJ-PD
Bone Drill

Order code	Speed
ND-1501(1)	0-1200 rpm



RJ-PD
Bone Drill
● Detachable drill chuck

Order code	Speed
ND-1501(2)	0-1200 rpm

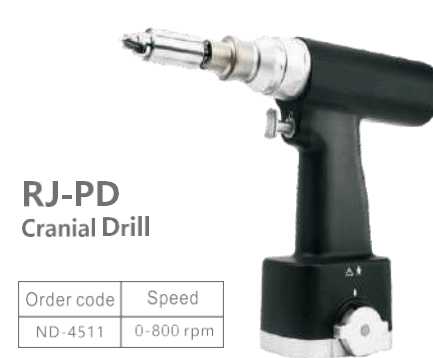

RJ-PD
Cranial Drill

Order code	Speed
ND-4511	0-800 rpm



RJ-PD
Canulate Drill

Order code	Speed
ND-2511(1)	0-1000 rpm



RJ-PD
Canulate Drill
● Detachable drill chuck

Order code	Speed
ND-2511(2)	0-600 rpm
ND-2511(3)	0-1000 rpm



RJ-PS
Oscillating Saw

Order code	Speed
NS-1511	0-18000 cpm



RJ-PS
Reciprocating Saw

Order code	Speed
NS-3531	0-14000 cpm



RJ-PS
Sternum Saw

Order code	Speed
NS-3532	0-14000 cpm



RJ-MP
Handpiece

Order code
NM500



Cranial drill adapter

Cranial mill adapter

Order code	Speed
NM5-4011	NM5-S091

Accessories

Accessory Description Order code



NI-MH battery charger/ Lithium battery charger PJDC1441 PJDC1480



NI-MH battery charger/ Lithium battery charger PJCG003 PJCG004



Battery Aseptic Transfer Kit PJXD003



Key For Drill Chuck PJYS002



Sterilization case for power tool



Order code PJDB004

*Power tools excluded

Power tool for big bone

Power tool for big bone



RJ-MP
Multifunctional
Handpiece

Order code
NM100

Multiple functions in one, wide range of applications.

Quick replacement of adapters, convenient and speedy.

Suitable for joint, trauma, neurosurgery, and intracardiac surgery; Applicable components consist of canulate drill adapter, K wire adapter, bone drill adapter, acetabular reaming drill adapter, oscillating saw adapter, cranial drill adapter, reciprocating saw adapter, sternum saw adapter, TPLO saw adapter and cranial mill adapter.



NM1-2001
Canulate Drill
Adapter

Item code	Gripping Range	Speed
MPN12001	0.8-7.9mm	0-1000 rpm
MPN12011	0.8-7.9mm	0-1000 rpm
MPN12021	0.8-7.9mm	0-1000 rpm



NM1-6001
K Wire Adapter

Item code	Gripping Range	Speed
MPN16001	0.8-2.0mm	0-1200rpm
MPN16002	1.5-3.2mm	0-1200rpm



NM1-1001
Bone Drill Adapter

Item code	Gripping Range	Speed
MPN11001	0.8-7.9mm	0-1200 rpm
MPN11021	/	0-1200 rpm



NM1-3011
Acetabular Reaming drill
Adapter

Item code	Gripping Range	Speed
MPN13011	1.0-8.1mm	0-300 rpm
MPN13021	1.0-8.1mm	0-300 rpm



NM1-S011
Oscillating Saw
Adapter

Item code	Gripping Range	Speed
MPN1S011	/	0-18000 cpm



NM1-S091
Cranial Mill Adapter

Item code	Gripping Range	Speed
MPN1S091	/	0-36000 rpm



NM1-4011
Cranial Drill Adapter

Item code	Gripping Range	Speed
MPN14011	/	0-800 rpm



NM1-S032
Sternum Saw
Adapter

Item code	Gripping Range	Speed
MPN1S032	/	0-14000 cpm



NM1-S031
Reciprocating Saw
Adapter

Item code	Gripping Range	Speed
MPN1S031	/	0-14000 cpm



NM1-S071
TPLO Saw Adapter

Item code	Gripping Range	Speed
MPN1S071	/	0-16000 cpm

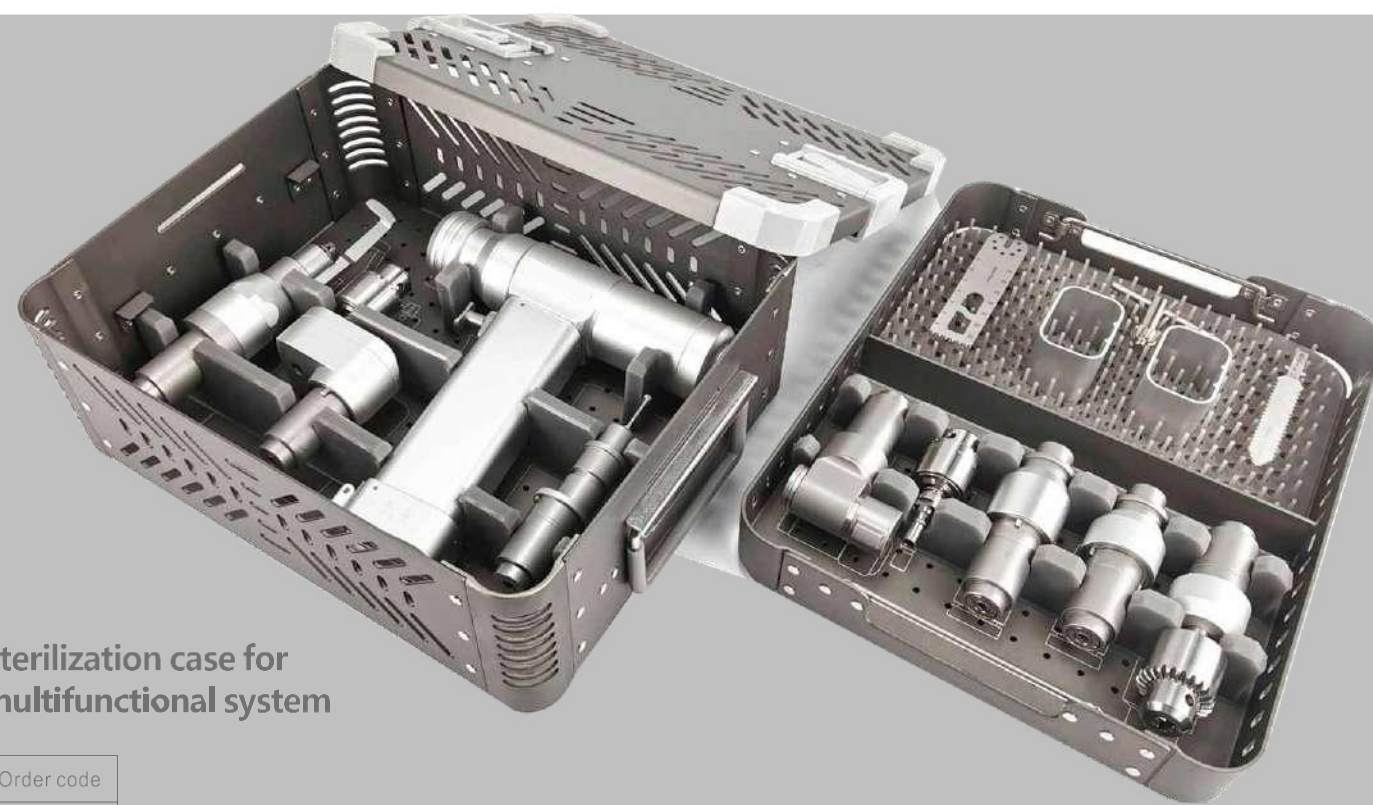

Sterilization case for
multifunctional system

Order code
PJDB005

*Power tools excluded

Power tool for big bone

Power tool for big bone



RJ-PD
Acetabular Reaming Drill

Order code	Speed
ND-3011	0-300 rpm

● Accept customization of various brands interface



Order code	Order code	Order code
PDN3011	PDN3021	PDN3031



RJ-PD
Bone Drill

Order code	Speed
ND-1001	0-1200 rpm



RJ-PD
Bone Drill

● Detachable drill chuck

Order code	Speed
ND-1001(2)	0-1200 rpm



RJ-PD
Canulate Drill

Order code	Speed
ND-2011(1)	0-1000 rpm



RJ-PD
Canulate Drill

● Detachable drill chuck

Order code	Speed
ND-2011(2)	0-600 rpm
ND-2011(3)	0-1000 rpm



RJ-PS
Oscillating Saw

Order code	Speed
NS-1011	0-18000 cpm



RJ-PS
Reciprocating Saw

Order code	Speed
NS-3031	0-14000 cpm



RJ-PS
Sternum Saw

Order code	Speed
NS-3032	0-14000 cpm

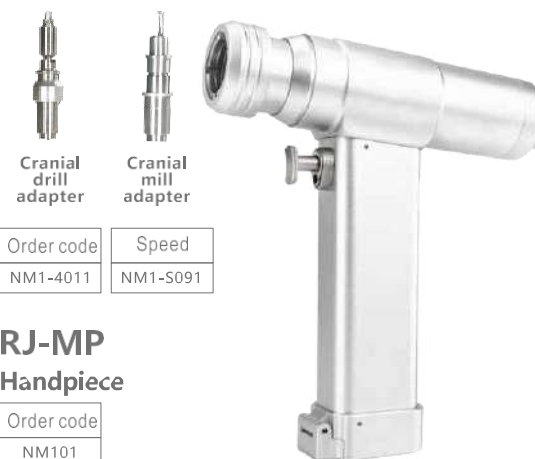

Cranial drill adapter
Cranial mill adapter

Order code	Speed
NM1-4011	NM1-S091

RJ-MP
Handpiece

Order code
NM101

Accessories



Accessory Description

Order code

NI-MH Battery

PJDC1440



Charge

PJCG001



Battery Aseptic Transfer Kit

PJXD001



Key For Drill Chuck

PJYS001

Sterilization case for power tool



Order code
PJDB006

*Power tools excluded



RJ-MP
Mini Multifunctional
Drill Saw System

Order code	NM300(1)
------------	----------



Components Description	Order code	Speed
Bone Drill Adapter	NM3-1001	0-1200rpm
AO quick coupling Adapter	NM3-1021	0-1200rpm
Oscillating Saw Adapter	NM3-S011	0-18000cpm
K Wire Adapter	NM3-6001	0-1200rpm



RJ-PS
Mini 360° Roating
Micro Oscillating
Saw

Order code	Speed
NS-2011	0-18000 rpm



RJ-PD
Micro Canulate Drill

Order code	Speed
ND-5002	0-1200 rpm



RJ-PD
Micro Bone Drill

Order code	Speed
ND-5001	0-1200 rpm

Accessories	
Accessory Description	Order code
Charger	PJCG001
Battery Aseptic Transfer Kit	PJXD001
NI-MH Battery 7-2V	PJDC0720
Key For Drill Chuck	PJYS003 PJYS004

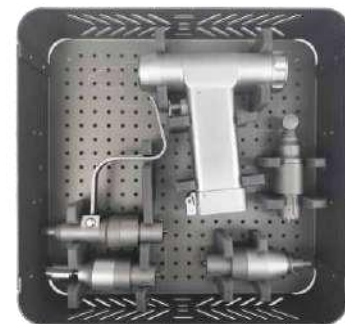

Sterilization case for power tool

Order code	PJDB007
------------	---------

*Power tools excluded



RJ-MP
Lithium Battery Operated
Brushless Mini
Multifunctional Saw Drill

Order code	EM300
------------	-------



Components Description	Order code	Speed
Bone Drill Adapter	NM3-1001	0-1200rpm
AO quick coupling Adapter	NM3-1021	0-1200rpm
Oscillating Saw Adapter	NM3-S011	0-18000cpm
K Wire Adapter	NM3-6001	0-1200rpm



RJ-PS
Lithium Battery Operated
Brushless Micro Bone Saw

Order code	Speed
ES-2011	0-18000 rpm



Accessories	
Accessory Description	Order code
Charger	PJCG002
Battery Aseptic Transfer Kit	PJXD005
Lithium battery	PJDC0741
Key For Drill Chuck	PJYS004



RJ-PD
Lithium Battery Operated
Brushless Micro Canulate Drill

Order code	Speed
ND-5002(E)	0-1200 rpm

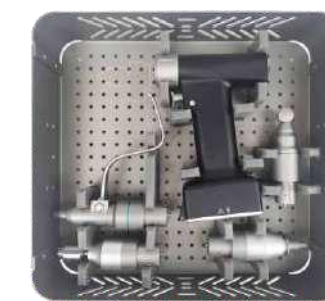

Sterilization case for power tool

Order code	PJDB007
------------	---------

*Power tools excluded



Order code	PJDB008
------------	---------

*Power tools excluded

Power tool for small bone

Power tool for small bone

Adaptor

Order code
PJZJ000

Customize interface according to needs.

Transfer connector \ Main interface	Main interface			
	Stryker	Johnson	AO	Hudson
Stryker	●	●	●	●
Johnson	●	●	●	●
AO	●	●	●	●
Hudson	●	●	●	●





RJ-PS Electric saw - TPLO saw

Order code	Power voltage	Speed
NS-1511(H)	12V	0-16000 cpm



Handpiece

Accessories

Accessory Description	Order code
	PJDC0120
	PJCG007
	PJXD007
	PJBS001

Size	8mm	10mm	12mm	15mm	18mm
20mm	21mm	24mm	27mm	30mm	33mm



Saw blades

Sterilization case for power tool

Order code
PJDB009

*Power tools excluded



Power tool for small bone

Autopsy Saw

Order code	Power voltage	Speed
NS-4041(J)	12V	0-16000 cpm



Handpiece

Spanner

Order code
PJBS002

Size
Φ52

Size
Φ43

Size
Φ64

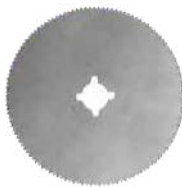

Control cabinet
connet handpiece



Power source console

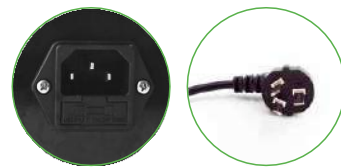

Power line

Plaster saw

Strong power, fast cutting, safe working, low noise

Order code	Power voltage	Speed
NS-4041	110V	0-13000 cpm
NS-4042	220V	0-13000 cpm

Spanner

Order code
PJBS002

Size
Φ52

Size
Φ43

Size
Φ64

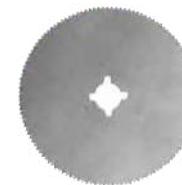

6 speed can be adjusted



Micro high speed drill I

Order code
RJ-MZ-I

Performance and application.

Straight handle: different length, applied in neurosurgery, spine surgery and microsurgery.
Angled handle: different length, applied in neurosurgery, spine surgery and microsurgery.

Power Console
Order code: PC1001

Pedal switch
Order code: FP-1001

Sterilization case for power tool
Order code: PJDB010
*Power tools excluded

Motor handpiece
Order code: BM1001

Straight attachment
Order code: SH1001

Angled attachment
Order code: AH1001

Cutting drill bit
Order code: MZMT001

Diamond drill bit
Order code: MZMT002

Hallux valgus mill blades
Order code: MZMT003

Helical end
Straight edge

Medical Shaver System

Order code
RJ-PX-I

Performance and application.

Used for shaving, cutting and grinding of bone tissue or soft tissue during surgery.

Power Console
Order code: PX-PC001

Motor handpiece (Connecting Interface)
Order code: PX-PM001

Pedal switch (Connecting Interface)
Order code: PX-FP001

Shaver blade
Order code: PX-PT001

Blade type

- Cutting spherical grinding bur type I
- Diamond spherical grinding bur type I
- Beveled edge shaver blade type I
- Cylindrical grinding bur type I
- Oblique without tooth shaver blade type I
- Flat with tooth inside and outside shaver blade type I

Micro high speed drill II

Order code
RJ-MZ-II

Product performance and application.

For microclinical drilling, reaming and bone grafting.

Power Console
Order code: PC2001

Pedal switch (Connecting Interface)
Order code: FP2001

Motor handpiece A
Order code: DM2001

Motor handpiece B
Order code: TM2001

Angled attachment
Order code: AH1001

Straight attachment
Order code: SH1001

Cranial Drill Adapter
Order code: CD2001

Reciprocating Saw Adapter
Order code: RS2001

Oscillating Saw Adapter
Order code: PS2001

Cranial Mill Adapter
Order code: CM2001

Cutting drill bit
Order code: MZMT001

Diamond drill bit
Order code: MZMT002

Hallux valgus mill blades
Order code: MZMT003

Sterilization case for power tool
Order code: PJDB011
*Power tools excluded

Helical end
Straight edge

*Optional extended motor/handle

Acetabular reamer shaft

Order code
PJAM001



Acetabular reamer

Order code
PJAM002



SIZE (Φ)	33	35	36	37	38
39	40	41	42	43	44
45	46	47	48	49	50
51	52	53	54	55	56
57	58	59	60	61	62
63	64	65	66		



Order code
PJDB012

*Acetabular reamer tool excluded

Sterilization case for Acetabular reamer tool

Hollow Drill Bits

Support different specifications customization.

Diameter (Φ)	Available length (mm)
1.8	100
2.0	150
2.7	150
3.0	150
3.2	150
3.5	150
4.0	250
4.5	200/250
4.8	250
5.0	200/250
5.5	300



Flexible Drill Bits (Detachable)

Support different specifications customization.

Diameter (Φ)	Available length (mm)
3.2	40/45/50
3.5	40/50
3.5	40/50
3.8	40/50
4.0	50
4.5	40/50



Flexible Drill Bits

Support different specifications customization.

Diameter (Φ)	Total length (mm)	Drill length/ Flute length (mm)
2.5	195	40/25
3.2	195	40/25
3.2	200	50/30
3.5	195	40/25

Twist drill bits

Support different specifications customization.

Diameter (Φ)	Available length (mm)
0.8	70/110
1.1	70/110
1.5	70/110
1.8	110
2.0	110/150
2.5	110/115/120/130/150
2.7	150
2.8	115/150
3.0	150
3.2	150/200
3.5	150
4.0	150
4.5	150

AO twist drill bits

Support different specifications customization.

Diameter (Φ)	Available length (mm)
1.1	60
1.5	85
1.8	110/125
2.0	100/110/145
2.5	110/145
2.8	145/180
3.5	195



Cranial Drill Adapter

Removable for cleaning, different sizes customization.

Diameter (Φ)		
Φ5	Φ8	Φ9
Φ10	Φ11	Φ12

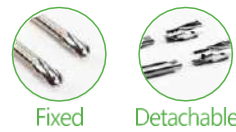

Flexible Reamer

AO interface for fixed head

Order code
PJFR001

AO interface for detachable head

Order code
PJFR003

Stryker interface for fixed head

Order code
PJFR002

Stryker interface for detachable head

Order code
PJFR004

SIZE (Φ)	Flexible reamer (fixed head)		Detachable flexible reamer	
	AO	Stryker	AO	Stryker
7	●	●		
7.2	●	●	●	●
7.5	●	●	●	●
8	●	●	●	●
8.5	●	●	●	●
9	●	●	●	●
9.5	●	●	●	●
10	●	●	●	●
10.5	●	●	●	●
11	●	●	●	●
11.5	●	●	●	●
12	●	●	●	●
12.5	●	●	●	●
13	●	●	●	●
13.5	●	●	●	●
14	●	●	●	●
14.5	●	●	●	●
15	●	●	●	●



Order code
PJDB013

*Flexible reamer excluded

Sterilization case for flexible reamer

Saw Blade:

Effective length: 90 mm

Length*Width (mm)	Thickness (mm)	Ruijin	Linvatec	Stryker	Zimmer/Synthes
90 X 24	1.0	PSB 10-90-24-QX	PSB 10-90-24-LF	PSB 10-90-24-SK	
	1.2	PSB 12-90-24-QX	PSB 12-90-24-LF	PSB 12-90-24-SK	
	1.27	PSB 127-90-24-QX	PSB 127-90-24-LF	PSB 127-90-24-SK	
90 X 22	0.8	PSB 08-90-22-QX			
	1.0	PSB 10-90-22-QX	PSB 10-90-22-LF	PSB 10-90-22-SK	
	1.2	PSB 12-90-22-QX	PSB 12-90-22-LF	PSB 12-90-22-SK	PSB 12-90-22-DS
	1.27	PSB 127-90-22-QX	PSB 127-90-22-LF	PSB 127-90-22-SK	PSB 127-90-22-DS
90 X 19	1.0	PSB 10-90-19-QX	PSB 10-90-19-LF		
	1.2	PSB 12-90-19-QX	PSB 12-90-19-LF	PSB 12-90-19-SK	
	1.27	PSB 127-90-19-QX			
90 X 13	0.8	PSB 08-90-13-QX			
	1.0	PSB 10-90-13-QX	PSB 10-90-13-LF	PSB 10-90-13-SK	PSB 10-90-13-DS
	1.2	PSB 12-90-13-QX	PSB 12-90-13-LF	PSB 12-90-13-SK	PSB 12-90-13-DS
	1.27	PSB 127-90-13-QX			

Effective length: 70 mm

70 X 24	1.0	PSB 10-70-24-QX	PSB 10-70-24-LF	PSB 10-70-24-SK	PSB 10-70-24-DS
	1.2	PSB 12-70-24-QX		PSB 12-70-24-SK	
70 X 22	0.8	PSB 08-70-22-QX			
	1.27	PSB 127-70-22-QX			
70 X 19	0.8			PSB 08-70-19-SK	
	1.0		PSB 10-70-19-LF		
	1.2		PSB 12-70-19-LF		
70 X 13	1.0	PSB 10-70-13-QX	PSB 10-70-13-LF	PSB 10-70-13-SK	

Saw blades Effective length: special dimension

Length*Width (mm)	Thickness (mm)	Ruijin	Length*Width (mm)	Thickness (mm)	Ruijin
30*10	0.5	PSB 05-30-10-QX	46*10	0.5	PSB 05-46-10-QX
35*8	0.5	PSB 05-35-08-QX	50*13	0.8	PSB 08-50-13-QX
39*13	0.5	PSB 05-39-13-QX	55*15	0.5	PSB 05-55-15-QX
45*32	1.2	PSB 12-45-32-QX			
Length*Width (mm)	Thickness (mm)	Stryker	Length*Width (mm)	Thickness (mm)	Zimmer/Synthes
100*25	1.2	PSB 12-100-25-QX	110*22	1.2	PSB 12-110-22-DS

RUIJIN Mirco sagittal saw blades

Length*Width (mm)	Thickness (mm)	
22*8	0.3	PSB 03-22-08-SQX
22*8	0.5	PSB 05-22-08-SQX
22*12	0.3	PSB 03-22-12-SQX
22*12	0.5	PSB 05-22-12-SQX
22*15	0.5	PSB 05-22-15-SQX
25*5.5	0.5	PSB 05-25-055-SQX
25*6.6	0.5	PSB 05-25-066-SQX
25*9.5	0.5	PSB 05-25-095-SQX
29.5*7	0.5	PSB 05-295-07-SQX
31*9.5	0.5	PSB 05-31-095-SQX
39*13	0.5	PSB 05-39-13-SQX
40*5	0.5	PSB 05-40-05-SQX
40*15	0.5	PSB 05-40-15-SQX
46*10	0.5	PSB 05-46-10-SQX
50*14	0.5	PSB 05-50-14-SQX

Other type micro sagittal saw blades

Length*Width (mm)	Thickness (mm)	Stryker
30*8.8	0.5	PSB 05-30-088-SK

Sternum saw blade:

Effective length*Width (mm)	Thickness (mm)	Interface	Saw-tooth	
38*7	0.8	RJ08	U	RSB 08-38-07-RJ08-U
38*7	1.0	RJ10	U	RSB 10-38-07-RJ10-U

Reciprocating saw blades:

Effective length*Width (mm)	Thickness (mm)	Interface	Saw-tooth	
90*11.5	1.0	RJ10	U	RSB 10-90-115-RJ10-U
78*13	1.0	RJ10	U	RSB 10-78-13-RJ10-U
70*8.5	1.0	RJ10	U	RSB 10-70-085-RJ10-U
51*9	1.0	RJ10	U	RSB 10-51-09-RJ10-U
50*11.5	1.0	RJ10	U	RSB 10-51-115-RJ10-U

Effective length*Width (mm)	Thickness (mm)	Interface	Saw-tooth	
90*11.5	1.0	RJ08	U	RSB 10-90-115-RJ08-U
78*13	1.0	RJ08	U	RSB 10-78-13-RJ08-U
70*8.5	1.0	RJ08	U	RSB 10-70-085-RJ08-U
51*9	1.0	RJ08	U	RSB 10-51-09-RJ08-U
50*11.5	1.0	RJ08	U	RSB 10-51-115-RJ08-U

Effective length*Width (mm)	Thickness (mm)	Interface	Saw-tooth	
70*13.4	1.0	RJ10	B	RSB 10-70-134-RJ10-B

Effective length*Width (mm)	Thickness (mm)	Interface	Saw-tooth	
70*13.4	1.0	RJ08	B	RSB 10-70-134-RJ08-B

Toothbrush Saws Blade:

Length (mm)	Cutting Length (mm)	Cutting Thickness (mm)	Ruijin
120	14	3.0	RSB 30-88-14-SK